

Dell™ Inspiron™ 4100

# Solutions Guide



## Hints, Notices, and Cautions



**HINT:** A HINT indicates important information that helps you make better use of your computer.



**NOTICE:** A NOTICE indicates either potential damage to hardware or loss of data and tells you how to avoid the problem.



**CAUTION:** A CAUTION indicates a potential for property damage, personal injury, or death.

## Abbreviations and Acronyms

For a complete list of abbreviations and acronyms, see the *Tell Me How* help file. To access the help file, see page 34.

---

Information in this document is subject to change without notice.

© 2001 Dell Computer Corporation. All rights reserved.

Reproduction in any manner whatsoever without the written permission of Dell Computer Corporation is strictly forbidden.

Trademarks used in this text: *Dell*, the *DELL* logo, *DellNet*, *DellPlus*, *Dell TravelLite*, *TrueMobile*, *Inspiron*, *Dell Precision*, *Dimension*, *OptiPlex*, *Latitude*, and *DellWare* are trademarks of Dell Computer Corporation; *Intel* and *Pentium* are registered trademarks and *Celeron* is a trademark of Intel Corporation; *Microsoft* and *Windows* are registered trademarks of Microsoft Corporation.

Other trademarks and trade names may be used in this document to refer to either the entities claiming the marks and names or their products. Dell Computer Corporation disclaims any proprietary interest in trademarks and trade names other than its own.

This product incorporates copyright protection technology that is protected by method claims of certain U.S. patents and other intellectual property rights owned by Macrovision Corporation and other rights owners. Use of this copyright protection technology must be authorized by Macrovision Corporation, and is intended for home and other limited viewing uses only unless otherwise authorized by Macrovision Corporation. Reverse engineering or disassembly is prohibited.

**November 2001    P/N 2H767    Rev. A00**

# Contents

<b>Safety and EMC Instructions: Portable Computers</b> . . . . .	<b>9</b>
Safety Instructions . . . . .	9
EMC Instructions . . . . .	13
When Using Your Computer . . . . .	14
Ergonomic Computing Habits . . . . .	15
When Removing or Replacing Parts . . . . .	17
Protecting Against Electrostatic Discharge . . . . .	17

## 1 Setting Up

<b>Connecting a Printer</b> . . . . .	<b>20</b>
Parallel Printer . . . . .	20
USB Printer . . . . .	21
Installing the Printer Driver . . . . .	22
<b>Transferring Information to a New Computer (Windows® XP Only)</b> . . . . .	<b>23</b>
<b>Setting Up a Home and Office Network (Windows XP Only)</b> . . . . .	<b>23</b>
<b>Turning Off the Computer</b> . . . . .	<b>24</b>
Windows Me and Windows 2000 . . . . .	24
<b>About the Module Bay</b> . . . . .	<b>24</b>
Swapping Devices While the Computer Is Turned Off . . . . .	25
Swapping Devices While Windows Is Running . . . . .	25
<b>Enabling the Infrared Sensor</b> . . . . .	<b>26</b>
<b>Setting Up the Dolby Headphone</b> . . . . .	<b>27</b>

<b>Setting Up the APR to Connect to a Network</b> . . . . .	<b>28</b>
<b>Power Protection Devices</b> . . . . .	<b>28</b>
Surge Protectors . . . . .	28
Line Conditioners . . . . .	29
Uninterruptible Power Supply Devices . . . . .	29

## 2 Solving Problems

<b>Finding Solutions</b> . . . . .	<b>32</b>
<b>Accessing Help</b> . . . . .	<b>34</b>
<b>Power Problems</b> . . . . .	<b>35</b>
<b>Error Messages</b> . . . . .	<b>36</b>
<b>Video and Display Problems</b> . . . . .	<b>38</b>
If the display is blank . . . . .	38
If the display is difficult to read . . . . .	39
If only part of the display is readable . . . . .	40
<b>Sound and Speaker Problems</b> . . . . .	<b>40</b>
If you have a problem with integrated speakers . . . . .	40
If you have a problem with external speakers . . . . .	40
<b>Printer Problems</b> . . . . .	<b>41</b>
If you cannot print to a parallel port printer . . . . .	41
If you cannot print to a USB printer . . . . .	42
<b>Modem and Internet Connection Problems</b> . . . . .	<b>43</b>
<b>Scanner Problems</b> . . . . .	<b>46</b>
<b>Touch Pad or Mouse Problems</b> . . . . .	<b>47</b>
<b>External Keyboard Problems</b> . . . . .	<b>48</b>
<b>Unexpected Characters</b> . . . . .	<b>49</b>

<b>Drive Problems</b> . . . . .	<b>49</b>
If you cannot save a file to a floppy disk . . . . .	49
If you cannot play a CD, CD-RW, or DVD . . . . .	51
If you cannot play a DVD movie . . . . .	52
If you cannot eject the CD, CD-RW, or DVD drive tray . . . . .	52
If you hear an unfamiliar scraping or grinding sound . . . . .	52
If the CD-RW drive stops writing . . . . .	52
If you have problems with a hard drive . . . . .	53
<b>Network Problems</b> . . . . .	<b>53</b>
<b>General Program Problems</b> . . . . .	<b>54</b>
A program crashes . . . . .	54
A program stops responding . . . . .	54
A solid blue screen appears . . . . .	55
A program is designed for an earlier version of the Windows operating systems . . . . .	55
Error messages appear . . . . .	55
<b>E-Mail Problems</b> . . . . .	<b>56</b>
<b>If Your Computer Gets Wet</b> . . . . .	<b>56</b>
<b>If You Drop or Damage Your Computer</b> . . . . .	<b>57</b>
<b>Resolving Other Technical Problems</b> . . . . .	<b>58</b>
<b>Reinstalling Drivers and Utilities</b> . . . . .	<b>58</b>
Reinstalling the Modem or Network Adapter Driver . . . . .	59
Using the Windows XP Device Driver Rollback . . . . .	61
<b>Resolving Software and Hardware Incompatibilities</b> . . . . .	<b>62</b>
Windows XP . . . . .	62
Windows Me . . . . .	63
Windows 2000 . . . . .	64
<b>Using System Restore</b> . . . . .	<b>65</b>
Windows XP . . . . .	65
Windows Me . . . . .	66
Creating a Restore Point . . . . .	66

Restoring the Computer to an Earlier Operating State . . . . .	67
Undoing the Last System Restore . . . . .	68
<b>Reinstalling Windows XP . . . . .</b>	<b>68</b>
<b>Reinstalling Windows Me . . . . .</b>	<b>70</b>
<b>Reinstalling Windows 2000 . . . . .</b>	<b>72</b>
Enabling Hibernate Support . . . . .	73

### 3 Replacing Parts

<b>Using the Advanced Port Replicator . . . . .</b>	<b>76</b>
Connecting External Devices to the APR . . . . .	76
APR Controls and Indicators . . . . .	78
Docking the Computer . . . . .	78
Undocking the Computer . . . . .	79
Monitor Stand . . . . .	81
<b>Adding Memory . . . . .</b>	<b>81</b>
<b>Adding a Mini PCI Card . . . . .</b>	<b>85</b>
<b>Replacing the Hard Drive . . . . .</b>	<b>87</b>
Returning a Hard Drive to Dell . . . . .	89
<b>Adding a Daughter Card Modem . . . . .</b>	<b>90</b>

### 4 Appendix

<b>Specifications . . . . .</b>	<b>94</b>
<b>Standard Settings . . . . .</b>	<b>101</b>
Viewing the System Setup Screens . . . . .	101
System Setup Screens . . . . .	101
<b>Returning Items for Warranty Repair or Credit . . . . .</b>	<b>102</b>

<b>Dell Technical Support Policy (U.S. Only)</b>	<b>102</b>
Definition of "Dell-Installed" Software and Peripherals	103
Definition of "Third-Party" Software and Peripherals	103
<b>Contacting Dell</b>	<b>103</b>
Returning Items for Warranty Repair or Credit	118
<b>Regulatory Information</b>	<b>118</b>
FCC Notices (U.S. Only)	119
Battery Disposal	122
NOM Information (Mexico Only)	123
Información para NOM (únicamente para México)	124
<b>Limited Warranties and Return Policy</b>	<b>124</b>
One-Year Limited Warranty (U.S. Only)	125
Two-Year Limited Warranty (U.S. Only)	127
Three-Year Limited Warranty (U.S. Only)	130
One-Year Limited Warranty (Canada Only)	133
Two-Year Limited Warranty (Canada Only)	135
Three-Year Limited Warranty (Canada Only)	138
"Total Satisfaction" Return Policy (U.S. and Canada Only)	142
One-Year End-User Manufacturer Guarantee (Latin America and the Caribbean Only)	143

<a href="#">Index</a>	<a href="#">145</a>
-----------------------	---------------------





# Safety and EMC Instructions: Portable Computers

The following information defines the meaning of *additional* symbols used *only* in the Safety and Electromagnetic Compatibility (EMC) Instructions.



Risk of explosion



Aircraft



Risk of fire



Use of this feature may be prohibited on aircraft



Risk of electric shock



## Safety Instructions

### General

- Do not attempt to service the computer yourself unless you are an authorized service technician. Always follow installation instructions closely.
- If you use an extension power cable with your AC adapter, ensure that the total ampere rating of the products plugged in to the extension power cable does not exceed the ampere rating of the extension cable.



- Do not push objects into air vents or openings of your computer. Doing so can cause fire or electric shock by shorting out interior components.



- Place the AC adapter in a ventilated area, such as a desk top or on the floor, when you use it to run the computer or to charge the battery. Do not cover the AC adapter with papers or other items that will reduce cooling; also, do not use the AC adapter inside a carrying case.

- Do not allow your portable computer to operate with the base resting directly on exposed skin for extended periods of time. The surface temperature of the base will rise during normal operation (particularly when AC power is present). Allowing sustained contact with exposed skin can cause discomfort or, eventually, a burn.



- Do not use your computer in a wet environment, for example, near a bath tub, sink, or swimming pool or in a wet basement.



- If your computer includes an integrated or optional (PC Card) modem, disconnect the modem cable if an electrical storm is approaching to avoid the remote risk of electric shock from lightning via the telephone line.



- To help avoid the potential hazard of electric shock, do not connect or disconnect any cables or perform maintenance or reconfiguration of this product during an electrical storm. Do not use your computer during an electrical storm unless all cables have been disconnected and the computer is operating on battery power.
- If your computer includes a modem, the cable used with the modem should be manufactured with a minimum wire size of 26 American wire gauge (AWG) and an FCC-compliant RJ-11 modular plug.
- PC Cards may become very warm during normal operation. Use care when removing PC Cards after their continuous operation.
- Before you clean your computer, remove power. Clean your computer with a soft cloth dampened with water. Do not use liquid or aerosol cleaners, which may contain flammable substances.



## Power (Safety Instructions, *continued*)



- Use only the Dell-provided AC adapter approved for use with this computer. Use of another AC adapter may cause a fire or explosion.
- Before you connect the computer to an electrical outlet, check the AC adapter voltage rating to ensure that the required voltage and frequency match the available power source.
- To remove power from the computer, turn it off, remove the battery pack, and disconnect the AC adapter from the electrical outlet.



- To help prevent electric shock, plug the AC adapter and peripheral power cables into properly grounded power sources. These power cables may be equipped with three-prong plugs to provide an earth grounding connection. Do not use adapter plugs or remove the grounding prong from the power cable plug. If you use a power extension cable, use the appropriate type, two-prong or three-prong, to mate with the AC adapter power cable.
- Be sure that nothing rests on your AC adapter's power cable and that the cable is not located where it can be tripped over or stepped on.



- If you are using a multiple-outlet power strip, use caution when plugging the AC adapter's power cable into the power strip. Some power strips may allow you to insert the plug incorrectly. Incorrect insertion of the power plug could result in permanent damage to your computer, as well as risk of electric shock and/or fire. Ensure that the ground prong of the power plug is inserted into the mating ground contact of the power strip.



## Battery (Safety Instructions, *continued*)



- Use only Dell battery modules that are approved for use with this computer. Use of other types may increase the risk of fire or explosion.



- Do not carry a battery pack in your pocket, purse, or other container where metal objects (such as car keys or paper clips) could short-circuit the battery terminals. The resulting excessive current flow can cause extremely high temperatures and may result in damage to the battery pack or cause fire or burns.
- The battery poses a burn hazard if you handle it improperly. Do not disassemble it. Handle a damaged or leaking battery pack with extreme care. If the battery is damaged, electrolyte may leak from the cells and may cause personal injury.
- Keep away from children.



- Do not store or leave your computer or battery pack near a heat source such as a radiator, fireplace, stove, electric heater, or other heat-generating appliance or otherwise expose it to temperatures in excess of 60°C (140°F). When heated to excessive temperatures, battery cells could explode or vent, posing a risk of fire.



- Do not dispose of your computer's battery in a fire or with normal household waste. Battery cells may explode. Discard a used battery according to the manufacturer's instructions or contact your local waste disposal agency for disposal instructions. Dispose of a spent or damaged battery promptly.



## Air Travel (Safety Instructions, *continued*)



- Certain Federal Aviation Administration regulations and/or airline-specific restrictions may apply to the operation of your Dell™ computer while you are onboard an aircraft. For example, such regulations/restrictions may prohibit the use of any personal electronic device (PED) that has the capacity for intentional transmission of radio frequency or other electromagnetic signals while on an aircraft.



- In order to best comply with all such restrictions, if your Dell portable computer is equipped with Dell TrueMobile™ or some other wireless communication device, please disable this device before you board the aircraft and follow all instructions provided by airline personnel with regard to such device.



- Additionally, the use of any PED, such as a portable computer, may be prohibited in aircraft during certain critical phases of flight, for example, takeoff and landing. Some airlines may further define the critical flight phase as any time the aircraft is below 3050 m (10,000 ft). Please follow the airline's specific instructions as to when the use of a PED is allowed.

## EMC Instructions

- Use shielded signal cables to ensure that you maintain the appropriate EMC classification for the intended environment. For parallel printers, a cable is available from Dell. If you prefer, you can order a cable from Dell at its world-wide website at <http://accessories.us.dell.com>.
- Static electricity can harm electronic components inside your computer. To prevent static damage, discharge static electricity from your body before you touch any of your computer's electronic components, such as a memory module. You can do so by touching an unpainted metal surface on the computer's input/output panel.

## When Using Your Computer

Observe the following safety guidelines to prevent damage to your computer:

- When setting up the computer for work, place it on a level surface.
  - When traveling, do not check the computer as baggage. You can put your computer through an X-ray security machine, but never put your computer through a metal detector. If you have the computer checked by hand, be sure to have a charged battery available in case you are asked to turn on the computer.
  - When traveling with the hard drive removed from the computer, wrap the drive in a nonconducting material, such as cotton cloth or paper. If you have the drive checked by hand, be ready to install the drive in the computer. You can put the hard drive through an X-ray security machine, but never put the drive through a metal detector.
  - When traveling, do not place the computer in overhead storage compartments where it could slide around. Do not drop your computer or subject it to other mechanical shocks.
  - Protect your computer, battery, and hard drive from environmental hazards such as dirt, dust, food, liquids, temperature extremes, and overexposure to sunlight.
  - When you move your computer between environments with very different temperature and/or humidity ranges, condensation may form on or within the computer. To avoid damaging the computer, allow sufficient time for the moisture to evaporate before using the computer.
-  **NOTICE:** When taking the computer from low-temperature conditions into a warmer environment or from high-temperature conditions into a cooler environment, allow the computer to acclimate to room temperature before turning on power.
- When you disconnect a cable, pull on its connector or on its strain-relief loop, not on the cable itself. As you pull out the connector, keep it evenly aligned to avoid bending any connector pins. Also, before you connect a cable make sure both connectors are correctly oriented and aligned.
  - Handle components with care. Hold a component such as a memory module by its edges, not its pins.

- When preparing to remove a memory module from the system board or disconnect a peripheral device from the computer, turn off the computer, disconnect the AC adapter cable, and then wait 5 seconds before proceeding to help avoid possible damage to the system board.
- Clean the display with a soft, clean cloth and commercial window cleaner that does not contain wax or abrasives. Apply the cleaner to the cloth; then stroke the cloth across the display in one direction, moving from the top of the display to the bottom. If the display contains grease or some other contaminant, use isopropyl alcohol instead of commercial window cleaner.
- If your computer gets wet or is damaged, follow the procedures described in "If Your Computer Gets Wet" on page 56. If, after following these procedures, you confirm that your computer is not operating properly, contact Dell (see page 103 for the appropriate contact information).

## Ergonomic Computing Habits



**CAUTION: Improper or prolonged keyboard use may result in injury.**



**CAUTION: Viewing the display or external monitor screen for extended periods of time may result in eye strain.**

For comfort and efficiency, observe the following ergonomic guidelines when setting up and using your computer:

- Position your computer directly in front of you as you work.
- Adjust the tilt of the computer's display, its contrast and/or brightness settings, and the lighting around you (such as overhead lights, desk lamps, and the curtains or blinds on nearby windows) to minimize reflections and glare on the display.
- When using an external monitor with your computer, set the monitor at a comfortable viewing distance (usually 510 to 610 millimeters [20 to 24 inches] from your eyes). Make sure the monitor screen is at eye level or slightly lower when you are sitting in front of the monitor.
- Use a chair that provides good lower-back support.
- Keep your forearms horizontal with your wrists in a neutral, comfortable position while using the keyboard, touch pad, track stick, or external mouse.

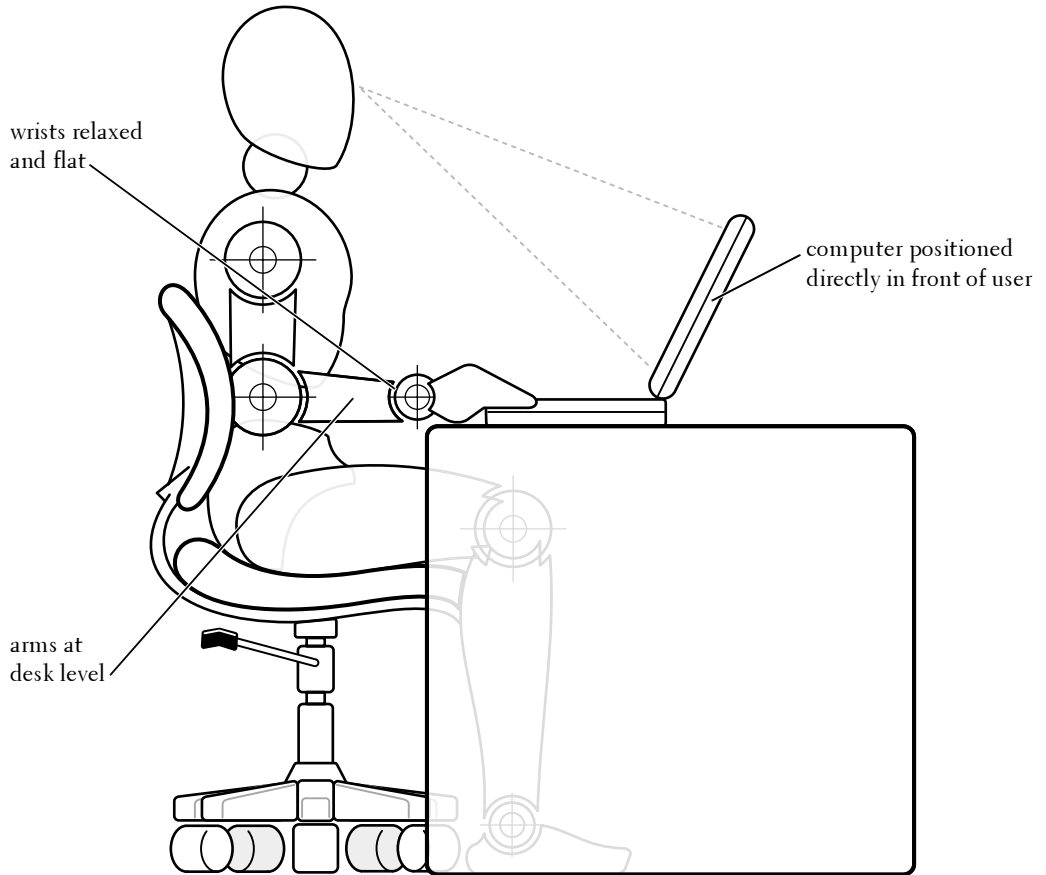

- Always use the palm rest with the keyboard, touch pad, or track stick. Leave space to rest your hands when using an external mouse.
- Let your upper arms hang naturally at your sides.
- Sit erect with your feet resting on the floor and your thighs level.
- When sitting, make sure the weight of your legs is on your feet and not on the front of your chair seat. Adjust your chair's height or use a footrest, if necessary, to maintain proper posture.
- Vary your work activities. Try to organize your work so that you do not have to type for extended periods of time. When you stop typing, try to do things that use both hands.





## When Removing or Replacing Parts

Before removing or installing memory modules, or adding a modem or Mini PCI card, perform the following steps in the sequence indicated.

-  **NOTICE:** The only time you should ever access the inside of your computer is when you are installing memory modules, or adding a modem or Mini PCI card.
-  **NOTICE:** Wait 5 seconds after turning off the computer before disconnecting a peripheral device or removing a memory module to help prevent possible damage to the system board.

- 1 Turn off your computer and any attached peripherals.
- 2 Disconnect your computer and peripherals from electrical outlets to reduce the potential for personal injury or shock. Also, disconnect any telephone or telecommunication lines from the computer.
- 3 Remove the main battery from the battery bay and, if necessary, the secondary battery from the module bay.
- 4 Ground yourself by touching the unpainted metal surface of the I/O panel on the back of the computer.

While you work, periodically touch the I/O panel to dissipate any static electricity that might harm internal components.

## Protecting Against Electrostatic Discharge

Static electricity can harm electronic components inside your computer. To prevent static damage, discharge static electricity from your body before you touch any of your computer's electronic components, such as a memory module. You can do so by touching an unpainted metal surface on the computer's I/O panel.

As you continue to work inside the computer, periodically touch an I/O connector to remove any static charge your body may have accumulated.

You can also take the following steps to prevent damage from electrostatic discharge (ESD):

- When unpacking a static-sensitive component from its shipping carton, do not remove the component from the antistatic packing material until you are ready to install the component. Just before unwrapping the antistatic packaging, be sure to discharge static electricity from your body.
- When transporting a sensitive component, first place it in an antistatic container or packaging.
- Handle all sensitive components in a static-safe area. If possible, use antistatic floor pads and workbench pads.

The following notice may appear throughout this document to remind you of these precautions:



**NOTICE:** See "Protecting Against Electrostatic Discharge" in the safety instructions.

SECTION 1
-----------

# Setting Up

Connecting a Printer

Transferring Information to a New Computer  
(Windows<sup>®</sup> XP Only)

Setting Up a Home and Office Network  
(Windows XP Only)

Turning Off the Computer

About the Module Bay

Enabling the Infrared Sensor

Setting Up the Dolby Headphone

Setting Up the APR to Connect to a Network

Power Protection Devices

## Connecting a Printer

See the documentation that came with the printer for any recommended preparation procedures, such as:

- Removing the packaging
- Installing the toner or ink cartridge
- Loading paper

Then follow the instructions that came with the printer to connect it to the computer. If no information is provided, see the following sections.



**HINT:** For complete printer driver installation instructions, refer to your printer documentation.

### Parallel Printer

- 1 Turn off the computer (see page 24).



**NOTICE:** Use only a standard IEEE 1284 parallel cable measuring 3 m (10 ft) or less to connect the printer to the computer. Use of a nonstandard cable may prevent the printer from working.

- 2 Attach the parallel printer cable to the parallel connector on the computer and tighten the two screws. Attach the cable to the parallel connector on the printer and snap the two clips into the two notches.

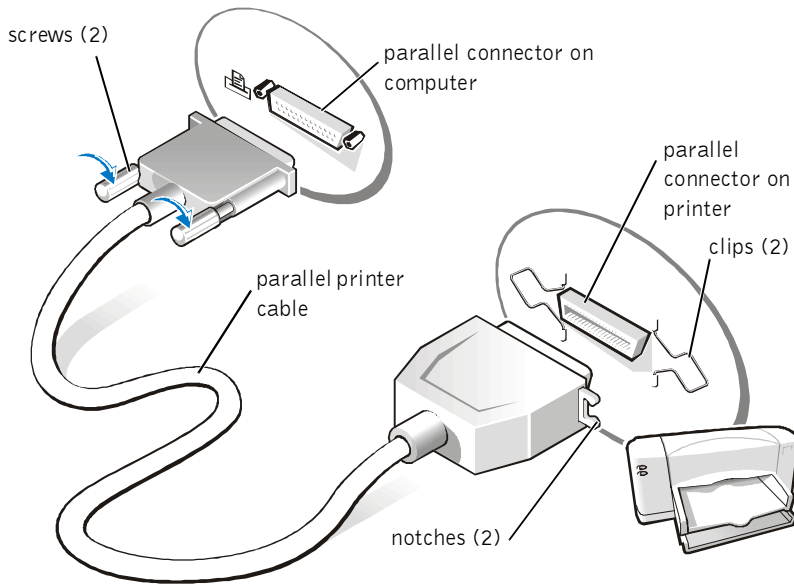

- 3 Turn on the printer and then turn on the computer. If the **Add New Hardware Wizard** window appears, click **Cancel**.
- 4 Install the printer driver if necessary (see page 22).

## USB Printer

- 1 Install the printer driver if necessary (see page 22).
- 2 Attach the USB printer cable to the USB connector on the computer and the printer. The USB connectors fit only one way.

 **HINT:** You can connect USB devices while the computer is turned on.

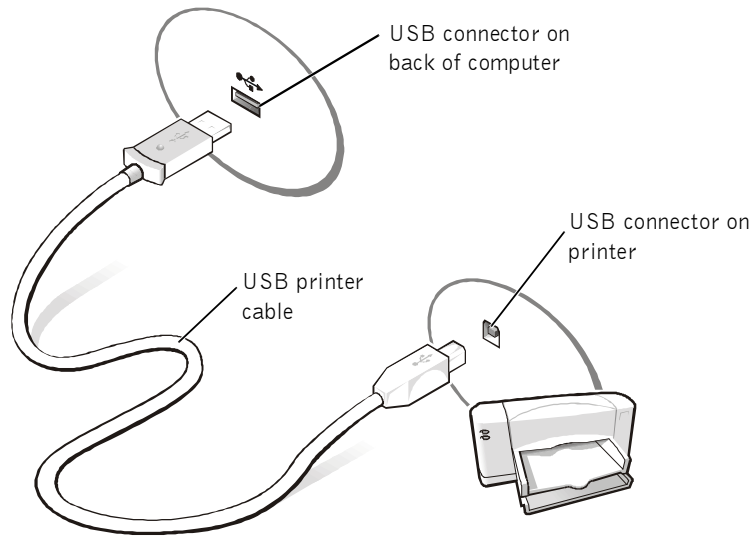

## Installing the Printer Driver

If you need to install a printer driver, insert the installation CD into the CD or DVD drive. Then follow the prompts on the screen and use the instructions that came with the printer.

If your printer installation CD does not automatically run, click the **Start** button, click **Run**, and type `x:\setup.exe` (where *x* is the letter of your CD or DVD drive [usually drive D]). Then click **OK** and follow the prompts on your screen. If your printer installation CD still does not run, check the documentation that came with your printer for instructions on how to start the printer installation CD.

To determine whether your printer driver is installed on a computer running the Microsoft® Windows XP operating system, click the **Start** button, click **Control Panel**, click **Printers and Other Hardware**, and then click **View installed printers or fax printers**. If your computer runs either Microsoft® Windows 2000 or Windows Millennium Edition (Me), click the **Start** button, point to **Settings**, and then click **Printers**. If your printer model is listed in the **Printers** window, the printer is ready to use.

## Transferring Information to a New Computer (Windows® XP Only)

Windows XP provides a **Files and Settings Transfer Wizard** to move data, such as e-mails, window sizes, toolbar settings, and Internet bookmarks, from one computer to another. First you collect the data from the source computer, and then you import the data to the new computer.

If the source computer uses another Windows operating system, you can launch the wizard from the Windows XP *Operating System* CD or from a floppy disk created on a computer that is running Windows XP. You can transfer the data to the new computer over a network or serial connection, or you can store it on a removable medium, such as a floppy disk, a Zip disk, or a writable CD.

- 1 On the computer running Windows XP, click the **Start** button, point to **All Programs**—> **Accessories**—> **System Tools**, and then click **Files and Settings Transfer Wizard**.
- 2 On the welcome screen, click **Next**.
- 3 On the **Which computer is this?** screen, select **New Computer**, and then click **Next**.
- 4 Follow the instructions on the screen.

## Setting Up a Home and Office Network (Windows XP Only)

Windows XP provides a **Network Setup Wizard** to guide you through the process of sharing files, printers, or an Internet connection between computers in a home or small office.

- 1 Click the **Start** button, point to **All Programs**—> **Accessories**—> **Communications**, and then click **Network Setup Wizard**.
- 2 On the welcome screen, click **Next**.
- 3 Click checklist for creating a network.

 **HINT:** Selecting the **This computer connects directly to the Internet** connection method enables the integrated firewall provided with Windows XP.

 **HINT:** If you are having difficulties turning off your computer, see "General Program Problems" on page 52.

- 4 Complete the checklist and required preparations, and then return to the **Network Setup Wizard**.
- 5 Follow the instructions on the screen.

## Turning Off the Computer

 **NOTICE:** To prevent data loss, you must turn off your computer through the **Start** menu rather than by pressing the power button.

### Windows XP

- 1 Save and close any open files and exit any open programs.
- 2 Click the **Start** button and then click **Turn off Computer**.
- 3 Click **Turn off**.

The computer automatically turns off after the shutdown process finishes.

### Windows Me and Windows 2000

- 1 Save and close any open files and exit any open programs.
- 2 Click the **Start** button and then click **Shut Down**.
- 3 Click the pull-down menu under **What do you want the computer to do?**.
- 4 Click **Shut down** and then click **OK**.

The computer automatically turns off after the shutdown process finishes.

## About the Module Bay

The module bay supports several types of devices, including the following:

- Floppy drive
- CD drive
- CD-RW drive
- DVD drive
- Zip drive
- Second hard drive





- Second battery
- Dell TravelLite™ module

 **NOTICE:** To prevent damage to the docking connector, do not remove or replace devices while the computer is connected to an advanced port replicator (APR).

## Swapping Devices While the Computer Is Turned Off

- 1 Save and close any open files, exit any open programs, and shut down the computer (see page 24).
- 2 If the computer is connected (docked) to an APR, undock it (see page 79).
- 3 Close the display and turn the computer over.
- 4 Slide and hold the latch release, and pull the device out of the module bay.

 **NOTICE:** To prevent damage to devices, place them in a travel case when they are not inserted into the computer. Store devices in a dry, safe place, and avoid pressing down on them or placing heavy objects on top of them.

 **NOTICE:** Insert devices before you dock and turn on the computer.

- 5 Insert the new device into the bay, and push it until you hear a click.
- 6 Turn on the computer.

## Swapping Devices While Windows Is Running

 **NOTICE:** To prevent damage to the docking connector, do not remove or replace devices while the computer is connected to an APR.

### In Microsoft Windows XP

- 1 Double-click the **Unplug** or **Eject Hardware** icon in the Windows taskbar.
- 2 Click the device you want to eject.
- 3 Keep the display open, and tilt the computer back so that you can access the bottom of the computer.
- 4 Slide and hold the latch release, and pull the device out of the bay.
- 5 Insert the new device into the bay, and push it until you hear a click.
- 6 If necessary, enter your password to unlock your computer.

### In Microsoft Windows Me

- 1 Right-click the **Softex BayManager** icon on the Microsoft Windows taskbar.
- 2 Click **Remove/Swap**.
- 3 Wait a few seconds until the device is ready to be ejected.
- 4 Keep the display open, and tilt the computer back so that you can access the bottom of the computer.
- 5 Slide and hold the latch release, and pull the device out of the module bay.
- 6 Insert the new device into the bay, and push it until you hear a click.
- 7 Click **OK**. Then click **OK** again to close the **Softex BayManager** window.

### In Microsoft Windows 2000



- 1 Double-click the **Unplug or Eject Hardware** icon on the Microsoft Windows taskbar.
- 2 Click the device you want to eject and then click **Stop**.
- 3 Click **OK**, and wait until the device you want to eject is cleared from the list of devices in the **Unplug or Eject Hardware** window.
- 4 Keep the display open, and tilt the computer back so that you can access the bottom of the computer.
- 5 Slide and hold the latch release, and pull the device out of the module bay.
- 6 Insert the new device into the bay, and push it until you hear a click.
- 7 When Windows recognizes the new device, click **Close**.

## Enabling the Infrared Sensor



**HINT:** You cannot use the infrared sensor when the computer is docked.

- 1 Turn on your computer, and enter the system setup program by pressing  when the Dell™ logo appears.

- 2 Press   and repeat to locate the **Infrared Data Port** option under the **Basic Device Configuration** heading of the system setup program.
- 3 Press the down-arrow key to highlight **Disabled** next to **Infrared Data Port**.
- 4 Press the right-arrow key to highlight a **COM** port.  
Ensure that the **COM** port that you highlight is different from the **Serial Port** and **Modem COM** ports.
- 5 Press the down-arrow key to highlight **Fast IR** or **Slow IR**.  
Dell recommends that you use **Fast IR**. If the infrared device cannot communicate with your computer, turn off the computer and repeat this procedure to change the setting to **Slow IR**.
- 6 Press  to save the changes and exit the system setup program.  
If you are prompted to restart your computer, click **Yes**.
- 7 Follow the instructions on the screen while the infrared sensor driver is installing.
- 8 At the end of the install process, click **Yes** to restart the computer.
- 9 When your computer detects the presence of another activated infrared device, double-click the infrared icon that appears on the Windows taskbar.
- 10 See the infrared device documentation for device setup instructions.



**HINT:** If the infrared device cannot communicate with your computer after you repeat this procedure to change the system setup program setting to **Slow IR**, contact the infrared device manufacturer.

## Setting Up the Dolby Headphone

- 1 Double-click the **Intervideo Win DVD** icon on the Windows desktop.
- 2 Click the **Properties** icon.
- 3 Click the **Dolby Headphone** tab.
- 4 Click **Enable Dolby Headphone**.
- 5 Select one of the four options to set the level of surround sound effects. **Option 1** is a baseline stereo option, and **Options 2, 3, and 4** are surround sound levels.



**HINT:** The Dolby headphone feature is available only if your computer has a DVD drive.





**HINT:** Icon labels may be visible only when you place the pointer over the icon.

 **HINT:** A network adapter is also referred to as a network interface controller (NIC).

- 6 Click **Apply**, and then click **OK** to close the **WinDVD Properties** window.
- 7 Click **Exit**.

## Setting Up the APR to Connect to a Network

-  **NOTICE:** Do not install a network adapter or a network adapter/modem combination PC Card until you complete the advanced port replicator (APR) setup.
-  **NOTICE:** To prevent serious operating system problems, do not dock your computer to an APR until the Windows operating system setup on the computer is complete.

An APR lets you more fully integrate your portable computer into a desktop environment.

For instructions and details on setting up an APR, refer to the documentation that came packaged with the device.

## Power Protection Devices

Several devices are available that protect against power fluctuations and failures. Power protection devices include:

- Surge protectors
- Line conditioners
- Uninterruptible power supplies (UPS)

### Surge Protectors

Surge protectors and power strips equipped with surge protection help to prevent damage to your computer from voltage spikes that can occur during electrical storms or following power interruptions. The level of protection is usually commensurate with the cost of the surge protector. Some surge protector manufacturers include warranty coverage for certain types of damage. Dell recommends that you carefully read the device warranty when choosing a surge protector. Compare joule ratings to determine the relative effectiveness of different devices.

 **NOTICE:** Most surge protectors do not protect against lightning strikes. Dell recommends that you disconnect your computer from the electrical outlet when lightning occurs in your area.

 **NOTICE:** Surge protectors do not protect against power fluctuations or power interruptions.

Power surges on telephone lines can damage modems. Dell recommends that you disconnect the telephone line from the telephone wall jack during electrical storms. Many surge protectors have a telephone jack for modem protection. See the surge protector documentation for modem connection instructions.

 **NOTICE:** Network adapter protection is not available on surge protectors. Dell recommends that you disconnect the network cable from the network wall jack during electrical storms.

## Line Conditioners

 **NOTICE:** Line conditioners do not protect against power interruptions.

Line conditioners are designed to maintain AC voltage at a fairly constant level. Line conditioners can cost up to several hundred dollars more than surge protectors.

## Uninterruptible Power Supply Devices

 **NOTICE:** Loss of power while data is being saved to the hard drive may result in data loss or file damage.

A UPS protects against power fluctuations and interruptions. UPS devices contain a battery that provides temporary power to connected devices when AC power is interrupted. The battery charges while AC power is available. See the UPS manufacturer documentation for information on battery operating time and to ensure that the device is approved by Underwriters Laboratories (UL).

 **HINT:** To ensure maximum battery operating time, connect only your computer to a UPS. Connect other devices, such as a printer, to a separate power strip that provides surge protection.



## SECTION 2

# Solving Problems

- Finding Solutions
- Accessing Help
- Power Problems
- Error Messages
- Video and Display Problems
- Sound and Speaker Problems
- Printer Problems
- Modem and Internet Connection Problems
- Scanner Problems
- Touch Pad or Mouse Problems
- External Keyboard Problems
- Unexpected Characters
- Drive Problems
- Network Problems
- General Program Problems
- General Program Problems
- E-Mail Problems
- If Your Computer Gets Wet
- If You Drop or Damage Your Computer
- Resolving Other Technical Problems
- Reinstalling Drivers and Utilities
- Resolving Software and Hardware Incompatibilities
- Using System Restore
- Reinstalling Windows XP
- Reinstalling Windows Me
- Reinstalling Windows 2000

## Finding Solutions

Sometimes it's difficult to figure out where to go for answers. Use this chart to quickly find the answers to your questions.

 **HINT:** If you have a problem with an external device, see the device documentation or contact the manufacturer.

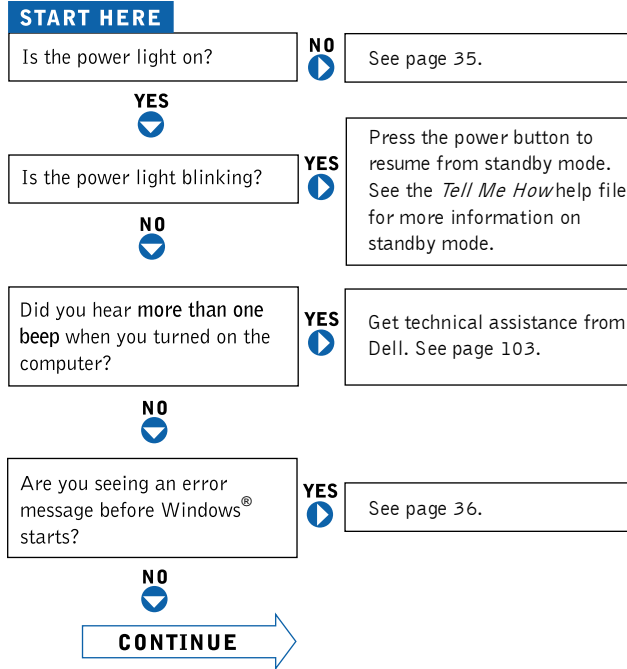



Are you having a problem with...

**NO**  
▶

- ▶ video or the display? **YES** ▶ See page 38.
- ▶ sound or the speakers? **YES** ▶ See page 40.
- ▶ the printer? **YES** ▶ See page 41.
- ▶ the modem? **YES** ▶ See page 42.
- ▶ the scanner? **YES** ▶ See page 46.
- ▶ the touch pad? **YES** ▶ See page 47.
- ▶ the external keyboard? **YES** ▶ See page 48.
- ▶ unexpected characters? **YES** ▶ See page 49.
- ▶ the hard drive or a disk drive? **YES** ▶ See page 49–53
- ▶ the network adapter? **YES** ▶ See page 53.
- ▶ Windows error messages? **YES** ▶ See page 36.
- ▶ a program? **YES** ▶ See page 54.
- ▶ the Internet? **YES** ▶ See page 42.
- ▶ your e-mail? **YES** ▶ See page 56.

Are you having some other type of problem?

**YES** ▶ See page 58.

# Accessing Help

## To ACCESS THE *Tell Me How* HELP FILE

Microsoft® Windows® XP

- 1 Click the **Start** button and then click **Help and Support**.
- 2 Click **User and system guides** and then click **User's guides**.
- 3 Click **Tell Me How**.

Windows Millennium Edition (Me) and Windows 2000

Click the **Start** button, point to **Programs**, point to **User's Guides**, and then click **Tell Me How**.

## To ACCESS HELP IN WINDOWS® XP

- 1 Click the **Start** button and then click **Help and Support**.
- 2 Type a word or phrase that describes your problem and then click the arrow icon.
- 3 Click the topic that describes your problem and then click **Display**.
- 4 Follow the instructions shown on the screen.

## To ACCESS HELP IN WINDOWS 2000

- 1 Click the **Start** button and then click **Help**.
- 2 Click the **Search** tab.
- 3 Type a word or phrase that describes your problem and then click **List Topics**.
- 4 Click the topic that describes your problem and then click **Display**.
- 5 Follow the instructions shown on the screen.

## To ACCESS HELP IN WINDOWS ME

- 1 Click the **Start** button and then click **Help**.
- 2 Type a word or phrase that describes your problem in the **Search** box and then click **Go**.
- 3 Click the topic that describes your problem and then click **Display**.
- 4 Follow the instructions shown on the screen.

# Power Problems

**CHECK THE POWER LIGHT** — When the power light is lit or blinking, the computer has power. If the power light is blinking, the computer is in standby mode—press the power button to exit standby mode. If the light is off, press the power button to turn on the computer.

**CHARGE THE BATTERY** — The battery charge may be depleted.

- 1 Reinstall the battery.
- 2 Use the AC adapter to connect the computer to an electrical outlet.
- 3 Turn on the computer.

**CHECK THE BATTERY STATUS LIGHT** — If the battery status light flashes orange or is a steady orange, the battery charge is low or depleted. Connect the computer to an electrical outlet.

If the battery status light flashes green and orange, the battery is too hot to charge. Turn off the computer (see page 24), disconnect the computer from the electrical outlet, and then let the battery and computer cool to room temperature.

If the battery status light rapidly flashes orange, the battery may be defective. Contact Dell (see page 103).

**TEST THE ELECTRICAL OUTLET** — Ensure that the electrical outlet is working by testing it with another device, such as a lamp.

**CHECK THE AC ADAPTER** — Check the AC adapter cable connections. If the AC adapter has a light, ensure that the light is on.

**CONNECT THE COMPUTER DIRECTLY TO AN ELECTRICAL OUTLET** —

Bypass power protection devices, power strips, and the extension cable to verify that the computer turns on.

**CHECK FOR INTERFERENCE** — Electrical appliances on the same circuit or operating near the computer can cause interference. Other causes of interference: power extension cables, too many devices on a power strip, or multiple power strips connected to the same electrical outlet.



**HINT:** See the *Tell Me How* help file for information on standby mode. To access the help file, see page 34.



**HINT:** If the message is not listed, see the documentation for the operating system or the program that was running at the time the message appeared.

**CHECK THE POWER PROPERTIES** — See the *Tell Me How* help file or search for the keyword *standby* in the Help and Support Center (*Help* in Windows Me and Windows 2000). To access help, see page 34.

**RESET THE MEMORY MODULES** — If the computer power light turns on but the display remains blank, reset the memory modules (see page 81).

## Error Messages

**THE FILE BEING COPIED IS TOO LARGE FOR THE DESTINATION DRIVE** — The file that you are trying to copy is too large to fit on the disk, or the disk is too full. Try copying the file to a different disk or use a larger capacity disk.

**A FILENAME CANNOT CONTAIN ANY OF THE FOLLOWING CHARACTERS: \ / : \* ? " < > |** — Do not use these characters in filenames.

**INSERT BOOTABLE MEDIA** — The operating system is trying to boot to a nonbootable floppy disk or CD. Insert a bootable floppy disk or CD.

**NON-SYSTEM DISK OR DISK ERROR** — A floppy disk is in the floppy drive. Remove the floppy disk and restart the computer.

**NOT ENOUGH MEMORY OR RESOURCES. CLOSE SOME PROGRAMS AND TRY AGAIN** — You have too many programs open. Close all windows and open the program that you want to use.

**OPERATING SYSTEM NOT FOUND** — Reseat the hard drive (see page 87).

**A REQUIRED .DLL FILE WAS NOT FOUND** — The program that you are trying to open is missing an essential file. Remove and then reinstall the program.

*Windows XP*

- 1 Click the **Start** button.
- 2 Click **Control Panel**.
- 3 Click **Add or Remove Programs**.
- 4 Select the program you want to remove.
- 5 Click the **Change or Remove Program** icon.
- 6 See the program documentation for installation instructions.

*Windows Me*

- 1 Click the **Start** button, point to **Settings**, and then click **Control Panel**.
- 2 Double-click the **Add/Remove Programs** icon.
- 3 Select the program that you want to remove.
- 4 Click **Add/Remove** and follow the prompts on the screen.
- 5 See the program documentation for installation instructions.

*Windows 2000*

- 1 Click the **Start** button, point to **Settings**, and then click **Control Panel**.
- 2 Double-click the **Add/Remove Programs** icon.
- 3 Select the program that you want to remove.
- 4 Click **Change or Remove Programs** and follow the prompts on the screen.
- 5 See the program documentation for installation instructions.

**X:\ IS NOT ACCESSIBLE. THE DEVICE IS NOT READY** — Insert a disk into the drive and try again.

# Video and Display Problems

## If the display is blank

 **HINT:** If you are using a program that requires a higher resolution than your computer supports, Dell recommends that you attach an external monitor to your computer.

**CHECK THE POWER LIGHT** — When the power light is blinking, the computer has power.

- If the power light is blinking, the computer is in standby mode—press the power button to exit standby mode.
- If the power light is off, press the power button.
- If the power light is on, your power management settings may have caused the display to turn off. Try pressing any key or move the cursor to exit standby mode.



**CHECK THE BATTERY** — If you are using a battery to power your computer, the battery charge may be depleted. Connect the computer to an electrical outlet using the AC adapter, and turn on the computer.

**TEST THE ELECTRICAL OUTLET** — Ensure that the electrical outlet is working by testing it with another device, such as a lamp. If the device is plugged into a surge protector, try plugging it directly into an electrical outlet.





**CHECK THE AC ADAPTER** — Check the AC adapter cable connections. If the AC adapter has a light, ensure that it is on.

**CONNECT THE COMPUTER DIRECTLY TO AN ELECTRICAL OUTLET** — Bypass power protection devices, power strips, and the extension cable to verify that the computer turns on.

**CHECK THE POWER PROPERTIES** — Search for the keyword *standby* in the Help and Support Center (*Help* in Windows Me and Windows 2000). To access help, see page 34.

**SWITCH THE VIDEO IMAGE** — If your computer is attached to an external monitor, press   to switch the video image to the integrated display.

## If the display is difficult to read

**ADJUST THE BRIGHTNESS** — Press   to increase the brightness, or press   to decrease the brightness.

### **MOVE THE SUBWOOFER AWAY FROM THE COMPUTER OR MONITOR** —

If your external speaker system includes a subwoofer, ensure that the subwoofer is at least 60 cm (2 ft) away from the computer or external monitor.

**ELIMINATE POSSIBLE INTERFERENCE** — Turn off nearby fans, fluorescent lights, halogen lamps, or other appliances.

### **ROTATE THE COMPUTER TO FACE A DIFFERENT DIRECTION** —

Eliminate sunlight glare, which can cause poor picture quality.

### **ADJUST WINDOWS DISPLAY SETTINGS**

*Windows XP*

- 1 Click the **Start** button and then click **Control Panel**.
- 2 Click **Appearance and Themes**.
- 3 Click the area you want to change or click the **Display** icon.
- 4 Try different settings for **Color quality** and **Screen resolution**.

*Windows Me and Windows 2000:*

- 1 Click the **Start** button, point to **Settings**, and then click **Control Panel**.
- 2 Double-click the **Display** icon and then click the **Settings** tab.
- 3 Try different settings for **Colors** and **Screen area**.

**SEE "ERROR MESSAGES"** — If an error message appears, see page 36.

## If only part of the display is readable

### CONNECT AN EXTERNAL MONITOR

- 1 Turn off your computer and connect an external monitor to the computer.
- 2 Turn on the computer and the monitor and adjust the monitor brightness and contrast controls.

If the external monitor works, the computer display or video controller may be defective. Contact Dell (see page 103).

## Sound and Speaker Problems

### If you have a problem with integrated speakers

**ADJUST THE WINDOWS VOLUME CONTROL** — In Windows XP, click the speaker icon in the lower-right corner of your screen. In Windows Me and Windows 2000, double-click the speaker icon in the lower-right corner of the screen. Be sure that the volume is turned up and that the sound is not muted.

**ADJUST THE VOLUME USING KEYBOARD SHORTCUTS** — Press



to disable (mute) or reenable the integrated speakers.

**REINSTALL THE SOUND (AUDIO) DRIVER** — See page 58.

### If you have a problem with external speakers



**HINT:** The volume control in some MP3 players overrides the Windows volume setting. If you have been listening to MP3 songs, make sure that you did not turn the player volume down or off.

**CHECK THE SPEAKER CABLE CONNECTIONS** — See the setup diagram supplied with the speakers.

**TEST THE ELECTRICAL OUTLET** — Ensure that the electrical outlet is working by testing it with another device, such as a lamp. If the device is plugged into a surge protector, try plugging it directly into an electrical outlet.

**ENSURE THAT THE SPEAKERS ARE TURNED ON** — See the setup diagram supplied with the speakers.



**ADJUST THE WINDOWS VOLUME CONTROL** — *In Windows XP*, click the gray speaker icon in the lower-right corner of your screen. *In Windows Me and Windows 2000*, double-click the yellow speaker icon in the lower-right corner of the screen. Be sure that the volume is turned up and that the sound is not muted.

**TEST THE SPEAKERS** — Plug the speaker audio cable into the line-out connector on the computer. Ensure that the headphone volume control is turned up. Play a music CD.

**RUN THE SPEAKER SELF-TEST** — Some speaker systems have a self-test button on the subwoofer. See the speaker documentation for self-test instructions.

**ELIMINATE POSSIBLE INTERFERENCE** — Turn off nearby fans, fluorescent lights, or halogen lamps to check for interference.

**REINSTALL THE SOUND (AUDIO) DRIVER** — See page 58.

## Printer Problems

### If you cannot print to a parallel port printer

**CHECK THE PRINTER CABLE CONNECTIONS** — Ensure that the printer cable is properly connected to the computer (see page 20).

**TEST THE ELECTRICAL OUTLET** — Ensure that the electrical outlet is working by testing it with another device, such as a lamp.

**ENSURE THAT THE PRINTER IS TURNED ON** — See the documentation supplied with the printer.

### VERIFY THAT THE PRINTER IS RECOGNIZED BY WINDOWS

#### *Windows XP*

- 1 Click the **Start** button.
- 2 Click **Control Panel**.
- 3 Click **Printers and Other Hardware**.
- 4 Click **View installed printers or fax printers**. If your printer model is listed, right-click the printer icon.
- 5 Click **Properties**, and then select the **Ports** tab. Ensure that the **Print to the following port(s)**: setting is **LPT1 (Printer Port)**.

#### *Windows Me and Windows 2000*

- 1 Click the **Start** button, point to **Settings**, and then click **Printers**. If your printer model is listed, right-click the printer icon.
- 2 Click **Properties**, and then select the **Details** tab in Windows Me and the **Ports** tab in Windows 2000. Ensure that the **Print to the following port(s)**: setting is **LPT1 (Printer Port)**.

**REINSTALL THE PRINTER DRIVER** — See page 22.

## If you cannot print to a USB printer

**VERIFY THE PRINTER CABLE CONNECTIONS** — Ensure that the printer cable is connected as described on page 20.

**TEST THE ELECTRICAL OUTLET** — Ensure that the electrical outlet is working by testing it with another device, such as a lamp.

**ENSURE THAT THE PRINTER IS TURNED ON** — See the documentation supplied with the printer.

## VERIFY THAT THE PRINTER IS RECOGNIZED BY WINDOWS

### *Windows XP*

- 1 Click the **Start** button.
- 2 Click **Control Panel**.
- 3 Click **Printers and Other Hardware**.
- 4 Click **View installed printers or fax printers**. If your printer model is listed, right-click the printer name.
- 5 Click **Properties**, and then select the **Ports** tab. Ensure that the **Print to the following port(s)**: setting is **USB**.

### *Windows Me and Windows 2000*

- 1 Click the **Start** button, point to **Settings**, and then click **Printers**. If your printer model is listed, right-click the printer icon.
- 2 Click **Properties**, and then select the **Details** tab in Windows Me and the **Port** tab in Windows 2000. Ensure that the **Print to the following port(s)**: setting is **USB**.

**REINSTALL THE PRINTER DRIVER** — See page 20.

## Modem and Internet Connection Problems

- ➔ **NOTICE:** Connect the modem to an analog telephone wall jack only. Connecting the modem to a digital telephone network damages the modem.
- ➔ **NOTICE:** Modem and network connectors look similar. Do not plug a telephone line into the network connector.

**CHECK THE TELEPHONE WALL JACK** — Disconnect the telephone line from the modem and connect it to a telephone. Listen for a dial tone. Ensure that you have touchtone telephone service. Try connecting the modem to a different telephone wall jack.

### **CONNECT THE MODEM DIRECTLY TO THE TELEPHONE WALL JACK** —

If you have other telephone devices sharing the line, such as an answering machine, fax machine, surge protector, or line splitter, then bypass them and connect the modem directly to the telephone wall jack with the telephone line.

 **HINT:** If you can connect to your Internet service provider (ISP), your modem is functioning properly. If you are sure that your modem is working properly and you still experience problems, contact your ISP.

**CHECK THE CONNECTION** — Verify that the telephone line is connected to the modem.

**CHECK THE TELEPHONE LINE** — Try using a different telephone line. If you are using a line that is 3 m (10 ft) or more in length, try a shorter one.

**IRREGULAR DIAL TONE** — If you have voice mail service, you may hear an irregular dial tone when you have messages. Contact your telephone company for instructions on restoring a normal dial tone.

**TURN OFF CALL WAITING (CATCH-PHONE)** — See your telephone directory for instructions on deactivating this feature. Then adjust the dial-up networking connection properties.

*Windows XP*

- 1 Click the **Start** button and then click **Control Panel**.
- 2 Click **Printers and Other Hardware**, and then click **Phone and Modem Options**.
- 3 Click to highlight your type of connection in the displayed list.
- 4 Click the **Dialing Rules** tab and click the **Edit** button.
- 5 Click to place a check mark in the **To disable call waiting** box.
- 6 Select the disable code (for example, \*70) from the drop down menu.
- 7 Click **Apply** and then click **OK**.

*Windows Me*

- 1 Click the **Start** button, point to **Settings**, and then click **Control Panel**.
- 2 Double-click the **Modems** icon.
- 3 In the **Modems Properties** window, click the **Dialing Properties** button.
- 4 Ensure that **To disable call waiting, dial:** is checked and then select the proper code according to the information in your telephone directory.
- 5 Click the **Apply** button and then click the **OK** button.
- 6 Close the **Modems Properties** window.
- 7 Close the **Control Panel**.

*Windows 2000*

- 1 Click the **Start** button, point to **Settings**, and then click **Control Panel**.
- 2 Double-click the **Phone and Modems Options** icon.
- 3 In the **Locations** window, select the location for which you want to disable call waiting, and then click **Edit**.
- 4 Ensure that **To disable call waiting, dial:** is checked and then select the proper code according to the information in your telephone directory.
- 5 Click **Apply** and then click **OK**.
- 6 Close the **Phone and Modems Options** window.
- 7 Close the **Control Panel**.

**VERIFY THAT THE MODEM IS COMMUNICATING WITH WINDOWS***Windows XP*

- 1 Click the **Start** button.
- 2 Click **Control Panel**.
- 3 Click **Network and Internet Connections**.
- 4 Click **Internet Options**.
- 5 Click **Network Diagnostics** and perform the connectivity test.

*Windows Me*

- 1 Click the **Start** button, point to **Settings**, and then click **Control Panel**.
- 2 In the **Control Panel** window, double-click **Modems**.  
If multiple entries appear for the same modem, or if modems are listed that are not installed, delete the entries and restart the computer.
- 3 Click the **Diagnostics** tab.
- 4 Click the COM port for your modem.
- 5 Click **More Info** to verify that the modem is communicating with Windows.  
If all commands receive responses, the modem is operating properly.

*Windows 2000*

- 1 Click the **Start** button, point to **Settings**, and then click **Control Panel**.
- 2 Double-click **Phone and Modems**.  
If multiple entries for the same modem or modems are listed but not installed, delete the entries, restart the computer, and repeat steps 1 and 2.
- 3 Click the **Modems** tab.
- 4 Click the COM port for your modem.
- 5 Click **Properties**, click the **Diagnostics** tab, and then click **Query Modem** to verify that the modem is communicating with Windows.  
If all commands receive responses, the modem is operating properly.

## Scanner Problems

**CHECK THE POWER CABLE CONNECTION** — Ensure that the scanner power cable is firmly connected to a working electrical power source and that the scanner is turned on. If the device is plugged into a surge protector, try plugging it directly into an electrical outlet.

**CHECK THE SCANNER CABLE CONNECTION** — Ensure that the scanner cable is firmly connected to the computer and to the scanner.

**UNLOCK THE SCANNER** — Ensure that your scanner is unlocked if it has a locking tab or button.

**REINSTALL THE SCANNER DRIVER** — See the scanner documentation for instructions.

## Touch Pad or Mouse Problems

### CHECK THE TOUCH PAD SETTINGS

*Windows XP*

- 1 Click the **Start** button, click **Control Panel**, and then click **Printers and Other Hardware**.
- 2 Click **Mouse**.
- 3 Try adjusting the settings.

*Windows Me and Windows 2000*

- 1 Click the **Start** button, point to **Settings**, and then click **Control Panel**.
- 2 Double-click the **Mouse** icon.
- 3 Try adjusting the settings.

**CHECK THE MOUSE CABLE** — Shut down the computer (see page 24). Disconnect the mouse cable and check it for damage. For PS/2 cables, check the cable connector for bent or broken pins. Firmly reconnect the cable.

If you are using a mouse extension cable, disconnect it and connect the mouse directly to the computer.

**TO VERIFY THAT THE PROBLEM IS WITH THE MOUSE, CHECK THE TOUCH PAD**

- 1 Turn off the computer.
- 2 Disconnect the mouse.
- 3 Turn on the computer.
- 4 At the Windows desktop, use the touch pad to move the cursor around, select an icon, and open it.

If the touch pad operates correctly, the mouse may be defective.

**REINSTALL THE TOUCH PAD DRIVER** — See page 58.

## External Keyboard Problems

**CHECK THE KEYBOARD CABLE** — Shut down the computer (see page 24). Disconnect the keyboard cable and check it for damage. For PS/2 cables, check the cable connector for bent or broken pins. Firmly reconnect the cable.

If you are using a keyboard extension cable, disconnect it and connect the keyboard directly to the computer.

**CHECK THE EXTERNAL KEYBOARD**

- 1 Turn off the computer, wait 10 to 20 seconds, and turn it on again.
- 2 Verify that the numbers, capitals, and scroll lock lights on the keyboard blink during the boot routine.
- 3 From the *Windows XP* desktop, click **Start**, point to **All Programs**, point to **Accessories**, and click **Notepad**.
- 4 From the *Windows Me* or *Windows 2000* desktop, click **Start**, point to **Programs**, point to **Accessories**, and click **Notepad**.
- 5 Type some characters on the external keyboard and verify that they appear on the display.

If you cannot verify these steps, you may have a defective external keyboard.



### TO VERIFY THAT THE PROBLEM IS WITH THE EXTERNAL KEYBOARD, CHECK THE INTEGRATED KEYBOARD

- 1 Turn off the computer.
- 2 Disconnect the external keyboard.
- 3 Turn on the computer.
- 4 From the *Windows XP* desktop, click **Start**, point to **All Programs**, point to **Accessories**, and click **Notepad**.
- 5 From the *Windows Me* or *Windows 2000* desktop, click **Start**, point to **Programs**, point to **Accessories**, and click **Notepad**.
- 6 Type some characters on the integrated keyboard and verify that they appear on the display.

If the characters appear now but did not with the external keyboard, you may have a defective external keyboard.

## Unexpected Characters

**DISABLE THE NUMERIC KEYPAD** — Press  to disable the numeric keypad if numbers are displayed instead of letters. Verify that the numbers lock light is not lit.



**HINT:** When you attach an external keyboard, the integrated keyboard remains fully functional.

## Drive Problems

### If you cannot save a file to a floppy disk

**ENSURE THAT WINDOWS RECOGNIZES THE DRIVE** — In *Windows XP*, click the **Start** button and then click **My Computer**. In *Windows Me* and *Windows 2000*, double-click the **My Computer** icon on the *Windows* desktop. If the floppy drive is not listed, perform a full scan with your antivirus software to check for and remove viruses. Viruses can sometimes prevent *Windows* from recognizing the drive.

**ENSURE THAT THE DISK IS NOT WRITE-PROTECTED** — You cannot save data to a write-protected disk. See the following figure.



**TRY ANOTHER FLOPPY DISK** — Insert another disk to eliminate the possibility that the original disk is defective.

#### **REINSTALL THE DRIVE**

- 1** Save and close any open files, exit any open programs, and shut down the computer.
- 2** Remove the drive from the module bay. See "About the Module Bay" on page 24.
- 3** Reinstall the drive.
- 4** Turn on the computer.

**CLEAN THE DRIVE** — See the *Tell Me How* help file for instructions. To access the help file, see page 34.

## If you cannot play a CD, CD-RW, or DVD

**ENSURE THAT WINDOWS RECOGNIZES THE DRIVE** — In Windows XP, click the **Start** button and then click **My Computer**. In Windows Me and Windows 2000, double-click the **My Computer** icon on the Windows desktop. If the CD drive is not listed, perform a full scan with your antivirus software to check for and remove viruses. Viruses can sometimes prevent Windows from recognizing the drive.

**TRY ANOTHER DISC** — Insert another disc to eliminate the possibility that the original disc is defective.

**ADJUST THE WINDOWS VOLUME CONTROL** — In Windows XP, click the speaker icon in the lower-right corner of your screen. In Windows Me and Windows 2000, double-click the speaker icon in the lower-right corner of your screen. Be sure that the volume is turned up and that the sound is not muted.

### REINSTALL THE DRIVE

- 1 Save and close any open files, exit any open programs, and shut down the computer.
- 2 If the drive is installed in the module bay, remove the drive. See "About the Module Bay" on page 24 for instructions.  
If the drive is a fixed drive, review "If you have problems with a hard drive" on page 53.
- 3 Reinstall the drive.
- 4 Turn on the computer.

**CLEAN THE DRIVE OR DISC** — See the *Tell Me How* help file for instructions. To access the help file, see page 34.

### CHECK THE DRIVE FOR ERRORS

- 1 Remove the hard drive.
- 2 Insert the *Drivers and Utilities* CD for your computer and turn on the computer.
- 3 Verify that the drive light is blinking, indicating normal operation.



**HINT:** High-speed CD drive vibration is normal and may cause noise. This noise does not indicate a defect in the drive or the CD.



**HINT:** Because of different worldwide file types, not all DVD titles work in all DVD drives.

## If you cannot play a DVD movie

**ENSURE THAT WINDOWS RECOGNIZES THE DRIVE** — In *Windows XP*, click the **Start** button and click **My Computer**. In *Windows Me and Windows 2000*, double-click the **My Computer** icon on the Windows desktop. If the DVD drive is not listed, perform a full scan with your antivirus software to check for and remove viruses. Viruses can sometimes prevent Windows from recognizing the drive.

**TEST THE DRIVE WITH ANOTHER DVD** — Insert another DVD to eliminate the possibility that the original DVD is defective.

**CLEAN THE DISC** — See the *Tell Me How* help file for instructions. To access the help file, see page 34.

## If you cannot eject the CD, CD-RW, or DVD drive tray

- 1 Ensure that the computer is turned off.
- 2 Straighten a paper clip and insert one end into the eject hole at the front of the drive; push firmly until the tray is partially ejected.
- 3 Gently pull out the tray until it stops.

## If you hear an unfamiliar scraping or grinding sound

- Ensure that the sound is not caused by the program that is running.
- Ensure that the disk or disc is inserted properly.

## If the CD-RW drive stops writing

**DISABLE STANDBY MODE IN WINDOWS BEFORE WRITING TO A CD-RW DISK** —

See the *Tell Me How* help file or search for the keyword *standby* in the Help and Support Center (*Help* in *Windows Me* and *Windows 2000*). To access help, see page 34.

**CHANGE THE WRITE SPEED TO A SLOWER RATE** — See the help files for your CD creation software.

**CLOSE ALL OTHER OPEN PROGRAMS** — Closing all other open programs before writing to the CD-RW may alleviate the problem.

## If you have problems with a hard drive

**ALLOW THE COMPUTER TO COOL BEFORE TURNING IT ON** — A hot hard drive may prevent the operating system from starting. Try allowing the computer to return to room temperature before turning it on.

### RUN SCANDISK

*Windows XP and Windows 2000*

- 1** In Windows XP, click the **Start** button and click **My Computer**. In Windows 2000, double-click the **My Computer** icon on the Windows desktop.
- 2** Right-click the drive letter (local disk) that you want to scan for errors, and then click **Properties**.
- 3** Click the **Tools** tab.
- 4** Under **Error-checking**, click **Check Now**.
- 5** Click **Start**.

*Windows Me*

Click the **Start** button, point to **Programs**—> **Accessories**—> **System Tools**, and then click **ScanDisk**.

## Network Problems

**CHECK THE NETWORK CABLE CONNECTOR** — Ensure that the network cable is firmly connected to the optional internal connector on the computer and the network wall jack.



**HINT:** Software usually includes installation instructions in its documentation or on a floppy disk or CD.

#### CHECK THE NETWORK LIGHTS ON THE NETWORK CONNECTOR —

Green indicates that the network connection is active. If the status light is not green, try replacing the network cable. Amber indicates that the optional internal network adapter driver is loaded and the adapter is detecting activity.

**RESTART THE COMPUTER** — Try to log on to the network again.

**CONTACT YOUR NETWORK ADMINISTRATOR** — Verify that your network settings are correct and that the network is functioning.

## General Program Problems

### A program crashes

**SEE THE SOFTWARE DOCUMENTATION** — Many software manufacturers maintain websites with information that may help you solve the problem. Ensure that you properly installed and configured the program. Reinstall the program if necessary.

### A program stops responding

#### END THE PROGRAM —

- 1 Press and hold <Ctrl><Shift><Esc>.
- 2 *In Windows XP and Windows 2000*, click the **Applications** tab, and then select the program that is no longer responding. *In Windows Me*, select the program that is no longer responding.
- 3 Click the **End Task** button.

## A solid blue screen appears

**TURN THE COMPUTER OFF** — If the computer does not respond to a keystroke or a proper shutdown (see page 24), press the power button until the computer turns off. Press the power button again to restart the computer. The solid blue screen appears because you were not able to perform a proper Windows shutdown. ScanDisk automatically runs during the start-up process. Follow the instructions on the screen.

## A program is designed for an earlier version of the Windows operating systems

**RUN THE PROGRAM COMPATIBILITY WIZARD** — Windows XP provides a Program Compatibility Wizard that configures a program to run in an environment more similar to that of earlier Windows operating systems.

**1** Click the **Start** button, point to **All Programs** —> **Accessories**, and then click **Program Compatibility Wizard**.

**2** On the welcome screen, click **Next**.

Follow the instructions on the screen.

## Error messages appear

**REVIEW "ERROR MESSAGES"** — Look up the message and take the appropriate action. See the software documentation.

## E-Mail Problems

**ENSURE THAT YOU ARE CONNECTED TO THE INTERNET** — With the Outlook Express e-mail program open, click **File**. If **Work Offline** has a check mark next to it, click the check mark to remove it and connect to the Internet.

**BE SURE THAT YOU HAVE SUBSCRIBED TO AN INTERNET SERVICE PROVIDER** — Contact an Internet service provider to subscribe.

**CONTACT YOUR INTERNET SERVICE PROVIDER** — Contact your Internet service provider for assistance.

## If Your Computer Gets Wet



**CAUTION:** Perform this procedure only after you are certain that it is safe to do so. If the computer is connected to an electrical outlet, Dell recommends that you turn off AC power at the circuit breaker before attempting to remove the power cables from the electrical outlet. Use the utmost caution when removing wet cables from a live power source.

- 1 Turn off the computer (see page 24), disconnect the AC adapter from the computer, and then disconnect the AC adapter from the electrical outlet.
- 2 Remove the battery.
- 3 Wipe off the battery and put it in a safe place to dry.
- 4 Turn off any attached external devices, and disconnect them from their power sources and then from the computer.
- 5 Ground yourself by touching one of the metal connectors on the back of the computer.
- 6 Remove the module bay device (see page 24) and any installed PC Cards, wipe them off, and put them in a safe place to dry.
- 7 Remove the hard drive (see page 87).
- 8 Remove the memory modules (see page 81).
- 9 Open the display and place the computer right-side up across two books or similar props to let air circulate all around it. Let the computer dry for 24-48 hours in a dry area at room temperature.



 **NOTICE:** Do not use artificial means, such as a hair dryer or a fan, to speed the drying process.

 **CAUTION:** To help prevent electrical shock, verify that the computer is thoroughly dry before continuing with the rest of this procedure.

- 10 Ground yourself by touching one of the metal connectors on the back of the computer.
- 11 Replace the memory modules, the memory module cover, and the screw(s).
- 12 Turn on the computer and verify that it is working properly.  
The Dell logo should appear, along with the following message:  
No operating system found
- 13 Turn off the computer by pressing the power button.
- 14 Replace the hard drive.
- 15 Replace the module bay device and any PC Cards you removed.
- 16 Replace the battery.

If the computer does not start, or if you cannot identify the damaged components, contact Dell (see page 103).

## If You Drop or Damage Your Computer

- 1 Save and close any open files, exit any open programs, and shut down the computer (see page 24).
- 2 Disconnect the AC adapter from the computer and from the electrical outlet.
- 3 Remove and reinstall the battery.
- 4 Turn off any attached external devices, and disconnect them from their power sources and then from the computer.
- 5 Turn on the computer.

If the computer does not start, or if you cannot identify the damaged components, contact Dell (see page 103).

 **HINT:** See "Limited Warranties and Return Policy" on page 124 for information on your warranty coverage.

 **HINT:** See "Limited Warranties and Return Policy" on page 124 for information on your warranty coverage.

## Resolving Other Technical Problems

**GO TO THE DELL SUPPORT WEBSITE** — Go to [support.dell.com](http://support.dell.com) for help with general usage, installation, and troubleshooting questions. See "Dell Technical Support Policy (U.S. Only)" on page 100 for a description of the hardware and software support provided by Dell.

**E-MAIL DELL** — Go to [support.dell.com](http://support.dell.com) and then click E-Mail Dell in the Communicate list. Send an e-mail message to Dell about your problem; you can expect to receive an e-mail message from Dell within hours. See "Dell Technical Support Policy (U.S. Only)" on page 100 for a description of the hardware and software support provided by Dell.

**CONTACT DELL** — If you cannot solve your problem using the Dell™ support website or e-mail service, call Dell for technical assistance (see page 103). See "Dell Technical Support Policy (U.S. Only)" on page 100 for a description of the hardware and software support provided by Dell.

## Reinstalling Drivers and Utilities

The Dell *Drivers and Utilities* CD for your computer contains drivers for operating systems that may not be on your computer. Verify that the driver you are loading is under your operating system subdirectory.

To reinstall drivers for optional devices such as wireless communications, DVD drives, and ZIP drives, see the software CD and documentation that came with those devices.

You can also access and download new drivers, system tools, and documentation from Dell's technical support page at <http://support.dell.com>. For more information on using the operating system installed on your computer by Dell, see the operating system user's guide that came with your computer.



**NOTICE:** Before you reinstall drivers, make sure that your computer is undocked.

To install a driver or utility from your *Drivers and Utilities* CD:

- 1 Save your work in all open programs.
- 2 Insert your *Drivers and Utilities* CD into the CD or DVD drive.

In most cases, the CD should start running automatically. If it does not, start Microsoft® Windows® Explorer, click your CD drive directory to display the CD contents, and then double-click the **autoed.exe** file. The first time that you run the CD, it might prompt you to install setup files. Click **OK**, and follow the instructions on the screen to continue.

- 3 From the **Language** pull-down menu in the toolbar, select your preferred language for the driver or utility (if available).

A welcome screen appears.

- 4 Click **Next**.
- 5 Under **Search Criteria**, select the appropriate categories from the **System Model**, **Operating System**, **Device Type**, and **Topic** pull-down menus.

A link or links appear(s) for the specific drivers or utilities used by your computer.

- 6 Click the link of a specific driver or utility to display information about the driver or utility that you want to install.
- 7 Click the **Install** button (if present) to begin installing the driver or utility. At the welcome screen, follow the screen prompts to complete the installation.

If no **Install** button is present, automatic installation is not an option. For installation instructions, either see the appropriate instructions in the following subsections, or click the **Extract** button, follow the extracting instructions, and read the readme file.

If instructed to navigate to the driver files, click the CD directory on the driver information window to display the files associated with that driver.

## Reinstalling the Modem or Network Adapter Driver

If you ordered the internal modem, reinstall the modem driver. If you ordered the network adapter, reinstall the network adapter driver.

## Windows XP

- 1 Save and close any open files, exit any open programs, and insert the *Drivers and Utilities* CD into the CD or DVD drive.
- 2 Click the **Start** button, and click **Control Panel**.
- 3 Under **Pick a category**, click **Performance and Maintenance**.
- 4 Under or pick a **Control Panel** icon, click **System**.
- 5 Click the **Hardware** tab.
- 6 Click **Device Manager**.
  - *If you are installing a modem driver*, click **Modem** and then click the appropriate modem.
  - *If you are installing a network adapter*, click **Network adapters** and then click **3Com 3C920 Integrated Fast Ethernet Controller**.
- 7 Click **Action**, and then click **Update Driver**.
- 8 Click **Install from a list or specific location (Advanced)**, and then click **Next**.
- 9 Verify that **Search removable media** is selected, and then click **Next**.
- 10 When the name of the appropriate driver appears, click **Next**.
- 11 Click **Finish** and restart your computer.

## Windows Me

- 1 Save and close any open files, exit any open programs, and insert your *Drivers and Utilities* CD into the CD or DVD drive.
- 2 Click the **Start** button, point to **Settings**, and then click **Control Panel**.
- 3 Double-click the **System** icon.
- 4 Click the **Device Manager** tab.
  - *If you are installing a modem driver*, click **Modem** and then click the appropriate modem.
  - *If you are installing a network adapter driver*, click **Network adapters** and then click **3Com 3C920 Integrated Fast Ethernet Controller**.
- 5 Click **Properties** and click the **Driver** tab.



**HINT:** To see the **System** icon, you may need to click the **View all control panel options** link at the left side of the screen.

- 6 Click **Update Driver**.
- 7 Verify that **Automatic search for a better driver (Recommended)** is selected, and then click **Next**.
- 8 Click **Finish**, and then click **Yes** to restart the computer.

## Windows 2000

- 1 Save and close any open files, exit any open programs, and insert your *Drivers and Utilities* CD.
- 2 Click the **Start** button, point to **Settings**, and then click **Control Panel**.
- 3 Double-click the **System** icon.
- 4 Click the **Hardware** tab.
- 5 Click **Device Manager**.
  - *If you are installing a modem driver*, click **Modem** and then click the appropriate modem.
  - *If you are installing a network adapter*, click **Network adapters** and then click **3Com 3C920 Integrated Fast Ethernet Controller**.
- 6 Click **Action**, and then click **Properties**.
- 7 Click the **Driver** tab, click **Update driver**, and then click **Next**.
- 8 Verify that **Search for a suitable driver for my device (Recommended)** is selected, and then click **Next**.
- 9 Verify that **CD-ROM drives** is selected, and then click **Next**.
- 10 When the name of the appropriate driver appears, click **Next**.
- 11 Click **Finish** and restart your computer.

## Using the Windows XP Device Driver Rollback

The Windows XP Device Driver Rollback can replace a device driver with the previously installed version if you install a new device driver that causes system instability. If you cannot reinstall your previous driver with the Driver Rollback process, then use System Restore (see page 64) to attempt to return your operating system to its previous operating state before the new device driver installation:

- 1 Click the **Start** button, and then right-click **My Computer**.
- 2 Click **Properties**.
- 3 Click the **Hardware** tab, and then click **Device Manager**.
- 4 In the **Device Manager** window, right-click the device for which the new driver was installed and then click **Properties**.
- 5 Click the **Drivers** tab.
- 6 Click **Roll Back Driver**.

## Resolving Software and Hardware Incompatibilities

Windows XP, Windows Me, and Windows 2000 **IRQ** conflicts occur if a device either is not detected during the operating system setup or is detected but incorrectly configured. See the following subsection that corresponds to your operating system to check for **IRQ** conflicts on your computer.

### Windows XP

- 1 Click the **Start** button, and then click **Control Panel**.
- 2 Click **Performance and Maintenance**, and then click **System**.
- 3 Click the **Hardware** tab, and then click the **Device Manager** button.
- 4 In the **Device Manager** list, check for conflicts with the other devices.  
Conflicts are indicated by a yellow exclamation point (!) beside the conflicting device or a red X if the device has been disabled.
- 5 Double-click any conflicting device listed to bring up the **Properties** window so that you can determine what needs to be reconfigured or removed from the **Device Manager**.
- 6 Resolve these conflicts before checking specific devices.
- 7 Double-click the malfunctioning device type in the **Device Manager** list.
- 8 Double-click the icon for the specific device in the expanded list.  
The **Properties** window appears.

If an **IRQ** conflict exists, the **Device status** area in the **Properties** window reports what other devices are sharing the device's **IRQ**.

- 9 Resolve any **IRQ** conflicts.

You can also use the Windows XP Hardware Troubleshooter. To use the troubleshooter, click the **Start** button and click **Help and Support**. Type `hardware troubleshooter` in the **Search** field, and then click the arrow to start the search. Click **Hardware Troubleshooter** in the **Search Results** list. In the **Hardware Troubleshooter** list, click **I need to resolve a hardware conflict on my computer**, and then click **Next**.

## Windows Me

- 1 Click the **Start** button, point to **Settings**, and click **Control Panel**.
- 2 Double-click the **System** icon.
- 3 Click the **Device Manager** tab.
- 4 In the **Device Manager** list, check for conflicts with the other devices.

Conflicts are indicated by a yellow exclamation point (!) beside the conflicting device or a red X if the device has been disabled.

- 5 Double-click any conflicting device listed to bring up the **Properties** window so you can determine what needs to be reconfigured or removed from the **Device Manager**.
- 6 Resolve these conflicts before checking specific devices.
- 7 Double-click the malfunctioning device type in the **Device Manager** list.
- 8 Double-click the icon for the specific device in the expanded list.

The **Properties** window appears.

If an **IRQ** conflict exists, the **Device status** area in the **Properties** window reports what other devices are sharing the device's **IRQ**.

- 9 Resolve any **IRQ** conflicts.

You can also use the Windows Me Hardware Troubleshooter. To use the troubleshooter, click the **Start** button and click **Help**. Click **Troubleshooting** in the **What would you like help with?** list, click **Hardware & system device problems**, click **Hardware, memory, & others**, and then click **Hardware Troubleshooter**. In the **Hardware Troubleshooter** list, click **I need to resolve a hardware conflict on my computer**, and then click **Next**.

## Windows 2000

- 1 Click the **Start** button, point to **Settings**, and click **Control Panel**.
- 2 Double-click the **System** icon.
- 3 Click the **Hardware** tab.
- 4 Click **Device Manager**.
- 5 Click **View**, and then click **Resources by connection**.
- 6 Double-click **Interrupt request (IRQ)** to view the **IRQ** assignments.  
Conflicts are indicated by a yellow exclamation point (!) beside the conflicting device or a red X if the device has been disabled.
- 7 Double-click any conflicting device listed to bring up the **Properties** window so that you can determine what needs to be reconfigured or removed from the **Device Manager**. Resolve these conflicts before checking specific devices.
- 8 Double-click the malfunctioning device type in the **Device Manager** list.
- 9 Double-click the icon for the specific device in the expanded list.  
The **Properties** window appears.  
If an **IRQ** conflict exists, the **Device status** area in the **Properties** window reports what other devices are sharing the device's **IRQ**.
- 10 Resolve the **IRQ** conflicts.

You can also use the Windows 2000 Hardware Troubleshooter. To use the troubleshooter, click the **Start** button and click **Help**. Click **Troubleshooting and Maintenance** on the **Contents** tab, click **Windows 2000 troubleshooters**, and then click **Hardware**. In the **Hardware Troubleshooter** list, click **I need to resolve a hardware conflict on my computer**, and then click **Next**.



# Using System Restore

Windows XP and Windows Me provide a System Restore feature that allows you to return your computer to an earlier operating state if changes to the computer's hardware or software (including new hardware or program installations) or other system settings, have left the computer in an undesirable operating state. You can also undo the last "System Restore."

System Restore automatically creates system checkpoints. You can also manually create your own checkpoints by creating Restore Points. To limit the amount of hard disk space used, older restore points are automatically purged.

To resolve an operating system problem, you can use System Restore from Safe Mode or Normal Mode to return your computer to an earlier operating state.

System Restore does not cause you to lose personal files stored in the **My Documents** folder, data files, or e-mail messages after restoring the computer to an earlier operating state. If you restore the computer to an operating state that existed before you installed a program, the program's data files won't be lost, but you will have to reinstall the actual program again.

 **NOTICE:** It is important to make regular backups of your data files. System Restore does not monitor changes to or recover your data files. If the original data on the hard disk is accidentally erased or overwritten, or if it becomes inaccessible because of a hard disk malfunction, use your backup files to recover the lost or damaged data.

System Restore is enabled on your new computer. However, if you reinstall Windows XP or Windows Me with less than 200 MB of free hard-disk space available, System Restore is automatically disabled. Before you use System Restore, see the following subsections to confirm that it is enabled.

## Windows XP

- 1 Click the **Start** button and then click **Control Panel**.
- 2 Click **Performance and Maintenance**.
- 3 Click **System**.
- 4 Click the **System Restore** tab.
- 5 Make sure that **Turn off System Restore** is not checked.

## Windows Me

- 1 Click the **Start** button, point to **Settings**, and then click **Control Panel**.
- 2 Double-click the **System** icon.
- 3 Click the **Performance** tab.
- 4 Click **File System**.
- 5 Click the **Troubleshooting** tab, and make sure that **Disable System Restore** is not checked.

Before proceeding with any System Restore function, Dell recommends that you thoroughly read Microsoft's information about using System Restore. To access this information:

- 1 Click the **Start** button, point to **All Programs** (point to **Programs** in Windows Me) —>**Accessories** —>**System Tools**, and then click **System Restore**.
- 2 Click **Help** in the upper-right corner of the **Welcome to System Restore** screen.

## Creating a Restore Point

### Using the System Restore Wizard

In Windows XP, you can either use the System Restore Wizard or manually create the restore points. To use the System Restore Wizard, click the **Start** button, click **Help and Support**, click **System Restore**, and then follow the instructions on the **System Restore Wizard** window. You can also create and name a restore point if you are logged on as the computer administrator or a user with administrator rights.

### Manually Creating the Restore Points

- 1 Click the **Start** button, point to **All Programs** (point to **Programs** in Windows Me)—>**Accessories** —>**System Tools**, and then click **System Restore**.
- 2 Click **Create a restore point**.
- 3 Click **Next**.

- 4 Type a name for the new restore point in the **Restore point description** field.

The present date and time are automatically added to the description of the new restore point.

- 5 Click **Create** (click **Next** in Windows Me).
- 6 Click **OK** (click **Close** in Windows Me).

## Restoring the Computer to an Earlier Operating State

If problems occur after you install a device driver, first try using Device Driver Rollback (see page 59). If Device Driver Rollback does not resolve the problem, then use System Restore.

➔ **NOTICE:** Before restoring the computer to an earlier operating state, save and close all open files and exit all open programs. Do not alter, open, or delete any files or programs until the system restoration is complete.

- 1 Click the **Start** button, point to **All Programs** (point to **Programs** in Windows Me)—>**Accessories**—>**System Tools**, and then click **System Restore**.
- 2 Be sure **Restore my computer to an earlier time** is selected and click **Next**.
- 3 Click a calendar date to which you want to restore your computer.  
The **Select a Restore Point (Choose a Restore Point** in Windows Me) screen provides a calendar that allows you to see and select restore points. All calendar dates with available restore points appear in bold.
- 4 Select a restore point and click **Next**.

If a calendar date has only one restore point, then that restore point is automatically selected. If two or more restore points are available, click the restore point that you want to use.

➔ **NOTICE:** Save and close all open files and exit all open programs. Do not alter, open, or delete any files or programs until the system restoration is complete.

- 5 Click **Next** (click **OK** in Windows Me).

*In Windows XP*, the **Restoration Complete** screen appears after System Restore finishes collecting data, and then the computer automatically restarts.

In *Windows Me*, the **Restoration in Progress** screen appears, and then the computer automatically restarts.

- 6 After the computer restarts, click **OK**.

To change the restore point, you can either repeat the steps using a different restore point, or you can undo the restoration.

## Undoing the Last System Restore

 **NOTICE:** Save and close all open files and exit all open programs. Do not alter, open, or delete any files or programs until the system restoration is complete.

- 1 Click the **Start** button, point to **All Programs** (point to **Programs** in *Windows Me*)  
—>**Accessories**—>**System Tools**, and then click **System Restore**.

- 2 Click **Undo my last restoration** and click **Next**.

 **NOTICE:** Save and close all open files and exit all open programs. Do not alter, open, or delete any files or programs until the system restoration is complete.

- 3 Click **Next** (click **OK** in *Windows Me*).
- 4 The **System Restore (Undoing Last Restoration in Windows Me)** screen appears, and then the computer automatically restarts.
- 5 After the computer restarts, click **OK**.

## Reinstalling Windows XP

Before reinstalling the *Windows XP* operating system to correct a problem, try correcting the problem by using *Windows System Restore* (see page 66).

 **NOTICE:** The *Operating System* CD provides options for reinstalling the *Windows XP* operating system. The options can potentially overwrite files installed by Dell and possibly affect programs installed on your hard drive. Therefore, Dell does not recommend that you reinstall your operating system unless instructed to do so by a Dell technical support representative.

- 1 Insert the *Operating System* CD into the CD or DVD drive.
- 2 Shut down the computer (see page 23), and then turn on the computer.

- 3 Press any key when the **Press any key to boot from CD** message appears on the screen.
- 4 When the **Windows XP Setup** screen appears, press <Enter> to select **To set up Windows now**.
- 5 Read the information in the **License Agreement** window, and then press <F8> on your keyboard to agree with the license information.
- 6 If your computer already has Windows XP installed and you want to recover your current Windows XP data, type **R** to select the repair option, and then go to step 15.

If you want to install a new copy of Windows XP, press <Esc> to select the fresh copy option, and then press <Enter> on the next screen to select the highlighted partition (recommended). Then follow the instructions on the screen.

- 7 The **Windows XP Setup** screen appears and Windows XP begins to copy files and install the device drivers. The computer automatically restarts multiple times before it requires additional input.
- 8 When the **Welcome to Microsoft** screen appears, click the green arrow icon at the bottom of the screen to continue, and follow the instructions on the screen to finish the installation.
- 9 When the **Regional Settings** screen appears, select the settings for your locale, and then click **Next**.
- 10 Enter your name and organization in the **Personalize Your Software** screen, and then click **Next**.
- 11 If you are reinstalling Windows XP Home Edition, enter a name for your computer when the **Computer Name** window appears, and then click **Next**.

If you are reinstalling Windows XP Professional, enter a name for your computer and a password when the **Computer Name and Administrator Password** window appears, and then click **Next**.

- 12 If you have a modem installed, the **Modem Dialing Information** screen appears. Enter the requested information, and then click **Next**.
- 13 Enter the date, time, and time zone in the **Date and Time Settings** window, and then click **Next**.

- 14** If your computer has a network adapter, select the appropriate network settings. If your computer does not have a network adapter, you do not see this option.

Windows XP begins to install its components and configure the computer. The computer automatically restarts.

- 15** When the **Welcome to Microsoft** screen appears, click the green arrow icon at the bottom of the screen to continue. Follow the instructions on the screen to finish the installation.
- 16** Remove the CD from the drive.
- 17** Reinstall the appropriate drivers (see page 61).
- 18** Reinstall your virus protection software.

## Reinstalling Windows Me

Before reinstalling the Windows Me operating system to correct a problem, try correcting the problem by using Windows System Restore (see page 66).



**NOTICE:** The *Operating System* CD provides options for reinstalling your Windows Me operating system. The options can potentially overwrite files installed by Dell and possibly affect programs installed on your hard drive. Therefore, Dell does not recommend that you reinstall your operating system unless instructed to do so by a Dell technical support representative.



**NOTICE:** To prevent conflicts with Windows Me, you must disable any virus protection software installed on your computer before you reinstall Windows.

- 1** Turn on the computer, and enter the system setup program as directed by a Dell technical support representative or by performing the following steps:
  - a** Shut down the computer (see page 23).
  - b** Before the computer boots into Windows, press F2 to enter the system setup program.
  - c** Press Alt P - to move to the **Boot** menu.
  - d** In the system setup program **Boot** menu, follow the instructions on the screen to change the boot sequence so that the CD or DVD drive boots first. Then insert the *Operating System* CD into the drive.

e Press  to save your changes and exit the system setup program.

f Press any key to boot the computer from the CD.

2 At the **Welcome** window, click **OK**.

3 Double-click **Refresh Windows OS**.

4 Click **OK**.

5 Click **OK** again. The installation takes 25-45 minutes.

6 Remove the *Operating System* CD from the drive, and click **OK** to restart your computer.

The **Getting ready to run Windows for the first time** window appears.

7 If the mouse tutorial starts, press  to exit and then press .

8 Click the setting for the region closest to where you live, and then click **Next**.

9 Click the graphic that matches your keyboard layout, and then click **Next**.

10 In the **User Information** window, type your name and, optionally, company name, and then click **Next**.

The **License Agreement** window appears.

11 Read the agreement, click **I accept the Agreement**, and then click **Next**.

12 Type the Windows product key in the fields provided, and then click **Next**.

The product key is the bar code number found on the Microsoft Windows label, which is located on the computer.

13 When the **Start Wizard** window appears, click **Finish**.

The **Enter Windows Password** window appears. Type your user name and password and click **OK**, or click **OK** to continue without setting a password.







14 If the **Date/Time Properties** window appears, adjust the date and time properties, click **Apply**, and then click **OK**.

Windows updates the system settings and restarts your computer.



- 15 If you set a password in step 13, type your password and click **OK**. If you did not set a password, click **OK**.
- 16 Reinstall the appropriate drivers (see page 61).
- 17 Reenable your virus protection software.

## Reinstalling Windows 2000

 **NOTICE:** The *Operating System* CD provides options for reinstalling the Windows 2000 operating system. The options can potentially overwrite files installed by Dell and possibly affect programs installed on your hard drive. Therefore, Dell does not recommend that you reinstall your operating system unless instructed to do so by a Dell technical support representative.

- 1 Turn on the computer, and enter the system setup program as directed by a Dell technical support representative or by performing the following steps:
  - a Shut down the computer (see page 23).
  - b Before the computer boots into Windows, press  to enter the system setup program.
  - c Press   to move to the **Boot** menu.
  - d In the system setup program **Boot** menu, follow the instructions on the screen to change the boot sequence so that the CD or DVD drive boots first. Then insert the *Operating System* CD into the drive.
  - e Press  to save your changes and exit the system setup program.
  - f Press any key to boot the computer from the CD.
- 2 When the **Windows 2000 Setup** window appears, ensure that the **To setup Win2000 now**, press **ENTER** option is highlighted. Then press .
- 3 Read the information in the **License Agreement** window, and then press  to continue.



- 4 When the **Windows 2000 Professional Setup** window appears, press the arrow keys to select the Windows 2000 partition option that you want. Then press the key for the partition option you chose.
- 5 When the **Windows 2000 Professional Setup** window reappears, press the arrow keys to select the type of file system that you want Windows 2000 to use, and then press . The installation takes 25-45 minutes.
- 6 Press  again to restart your computer.
- 7 Click **Next** when the **Welcome to the Windows 2000 Setup Wizard** window appears.
- 8 When the **Regional Settings** window appears, select your region, and then click **Next**.
- 9 Enter your name and organization in the **Personalize Your Software** window, and then click **Next**.
- 10 Enter the Windows product key, which is printed on the Microsoft label on your computer. Then click **Next**.
- 11 When the **Computer Name and Administrator Password** window appears, enter a name for your computer and a password, if desired. Then click **Next**.
- 12 Enter the date and time in the **Date and Time Settings** window, and then click **Next**.  
Windows 2000 installs components and configures the computer.
- 13 When the **Completing the Windows 2000 Setup Wizard** window appears, remove the CD from the drive, and then click **Finish**.  
The computer automatically restarts.

### **Enabling Hibernate Support**

- 1 Click the **Start** button, point to **Settings**, and click **Control Panel**.
- 2 Double-click the **Power Management** icon.
- 3 Click the **Hibernate** tab.
- 4 Ensure that **Enable hibernate support** is selected, and click **Apply**.
- 5 Click **OK** to close Control Panel.



**SECTION 3**

# Replacing Parts

- Using the Advanced Port Replicator
- Adding Memory
- Adding a Mini PCI Card
- Replacing the Hard Drive
- Adding a Daughter Card Modem

**HINT:** If you receive a BIOS upgrade floppy disk with your APR, use the disk to upgrade your computer before you use the APR.

**HINT:** If the cable connector from the external device has thumbscrews, be sure to tighten them to ensure a proper connection.

## Using the Advanced Port Replicator

The advanced port replicator (APR) integrates your computer into a desktop environment. The APR includes a network adapter to connect your computer to a network.

**NOTICE:** Do not attempt to lift the computer while it is connected to the APR. Doing so will damage the docking connector.



### Connecting External Devices to the APR



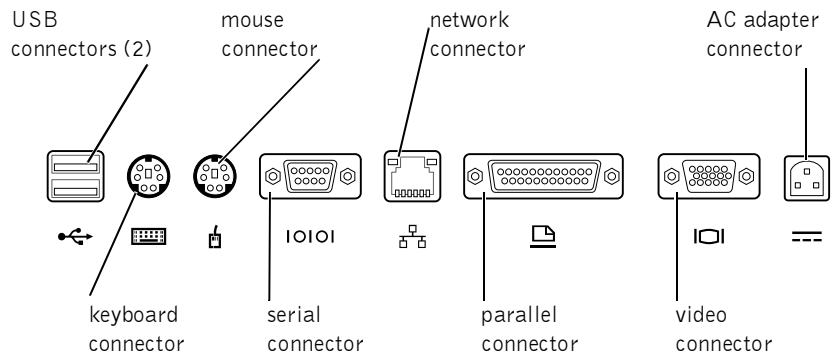

- 1 See the following illustrations to help you connect the devices to the appropriate APR connector.

The I/O connectors on the back and side of the APR duplicate the primary connectors on the back and side of your computer.

- 2 Connect the external devices to an electrical outlet, if applicable.



Connector Icon	Connector Description
	Connect one or two USB devices, such as a USB mouse.
	Connect a PS/2-style keyboard or numeric keypad.

Connector Icon <i>(continued)</i>	Connector Description
	Connect a PS/2-compatible mouse.
10101	Connect a serial device, such as a serial mouse or digital camera.
	Connect a network interface cable.
	Connect a parallel device, such as a printer.
	Connect an external monitor.
	Connect the AC adapter.

The audio line-out connector is on the side of the APR.

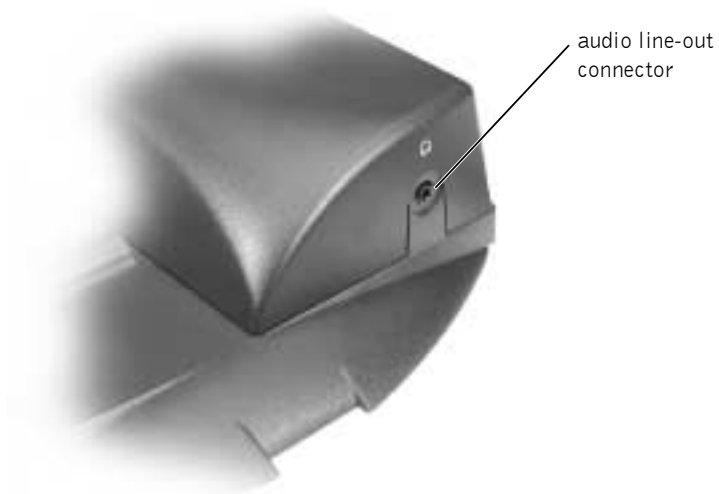

## APR Controls and Indicators

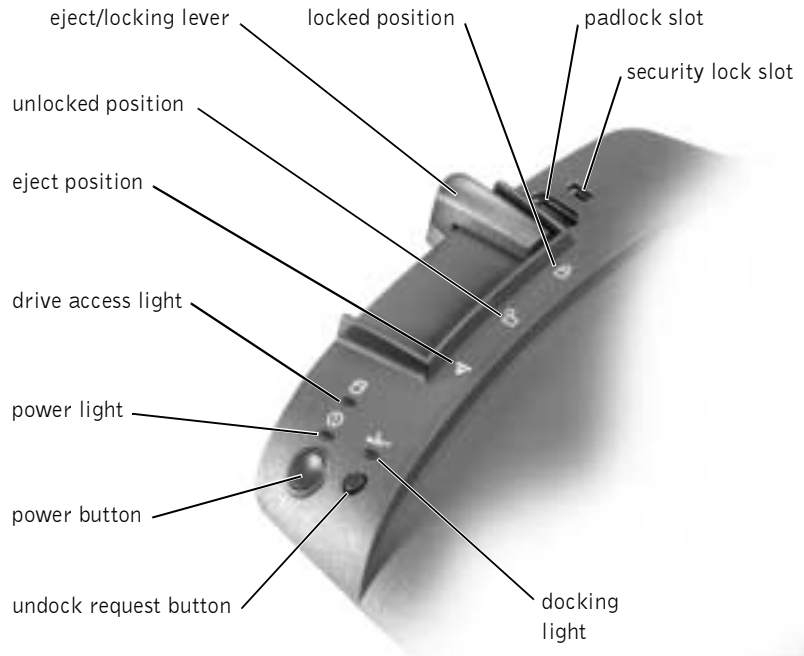

## Docking the Computer

**➡ NOTICE:** Before you initially connect your computer to the APR, you must complete the operating system setup. When you see the Microsoft® Windows® desktop on your screen, the operating system setup is complete.

You *dock* your computer when you connect it to an APR. You must connect the AC adapter to the APR before you dock and turn on the computer. The AC adapter powers the APR and the computer at the same time. Any battery installed in the computer charges while you use the APR.

**➡ NOTICE:** Always use the Dell AC adapter that came with the APR. If you use any other commercially available AC adapter—or the AC adapter from other Dell computers—you may damage the APR or the computer.

- 1 Save and close all open files, exit all open programs, and shut down the computer (see page 24).

- 2 Disconnect any external devices, and remove any PC Cards from the computer.
- 3 Connect the AC adapter to the connector on the APR, and connect the AC power cable to an electrical outlet.
- 4 Horizontally center the computer on the APR base, with the back of the computer facing the APR docking connector.
- 5 Slide the computer toward the connector until you feel the grooves on the bottom of the computer engage with the alignment rails.

**→ NOTICE:** If you attempt to push the computer all the way into the APR without engaging the alignment rails, you may irreparably damage the docking connector on the computer. If you have a monitor stand installed, you will not be able to see the alignment rails or the docking connector.

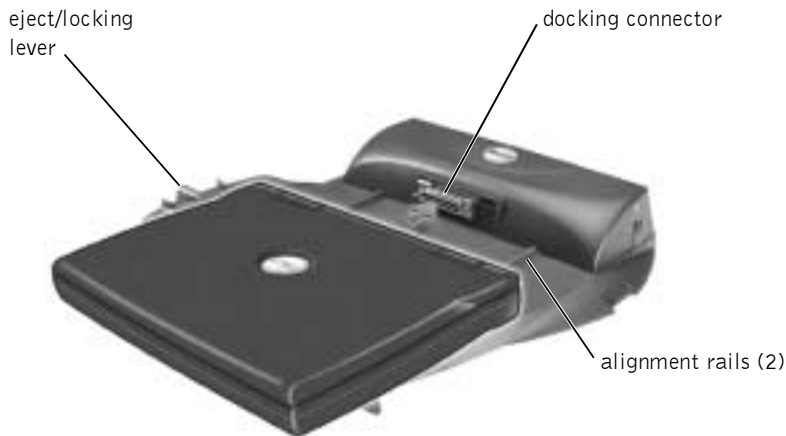

- 6 Gently push the computer forward until the docking connector is fully engaged.
- 7 Slide the eject/locking lever towards the back of the APR to the locked position.

## Undocking the Computer

**→ NOTICE:** If you do not have a charged battery installed in the computer when you undock the computer, you may lose unsaved data.

➡ **NOTICE:** If you do not use correct undocking procedures, you may lose data and the computer may not restart.

- 1 Save and close all open files and exit all open programs.
- 2 Perform one of the following procedures:
  - Click the **Start** button, and then click **Eject PC**.  
After a few seconds, the computer power light turns off.
  - Press the undock request button on the APR.  
After a few seconds, the green docking light turns off.
  - Shut down the computer.
- 3 Slide the eject/locking lever on the left side of the APR to the eject position to undock the computer.





## Monitor Stand

**NOTICE:** The stand supports monitors that weigh up to 45.3 kg (100 lb). Heavier monitors may damage the stand, computer, and APR.

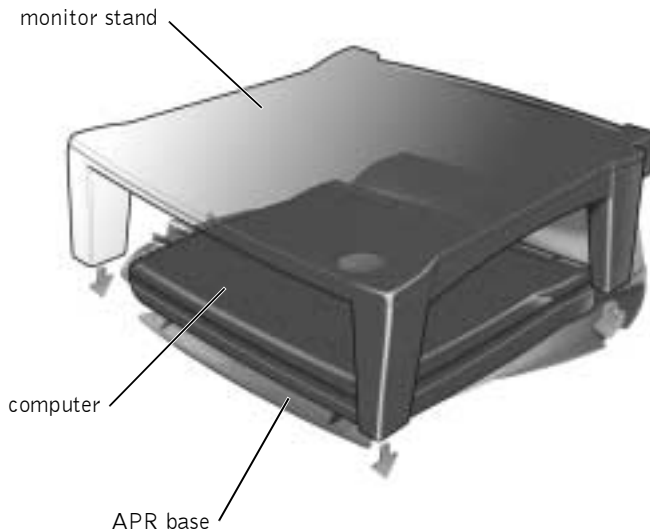

**HINT:** Be sure that the back legs on the monitor stand engage the slots on either side of the APR base.

## Adding Memory

You can increase your computer memory by installing memory modules on the system board. See "Specifications" on page 94 for information on the memory supported by your computer. Be sure to add only memory modules that are intended for your computer.

**CAUTION:** Before working inside your computer, read "When Removing or Replacing Parts" on page 17.

- 1 Save and close any open files, exit any open programs, and shut down the computer (see page 24).
- 2 If the computer is docked, undock it.
- 3 Remove any installed PC Cards.

**HINT:** Memory modules purchased from Dell are covered under your computer warranty.

- 4 Remove all installed batteries, and disconnect the AC adapter cable and any external devices from the computer. Wait 5 seconds before proceeding.
- 5 Ground yourself by touching a metal connector on the back of the computer.
- ➔ **NOTICE:** While you work, periodically touch unpainted metal on the computer to dissipate static electricity that might harm internal components.
- 6 Turn the computer over, remove the screw(s) from the memory module cover, and lift up the cover.

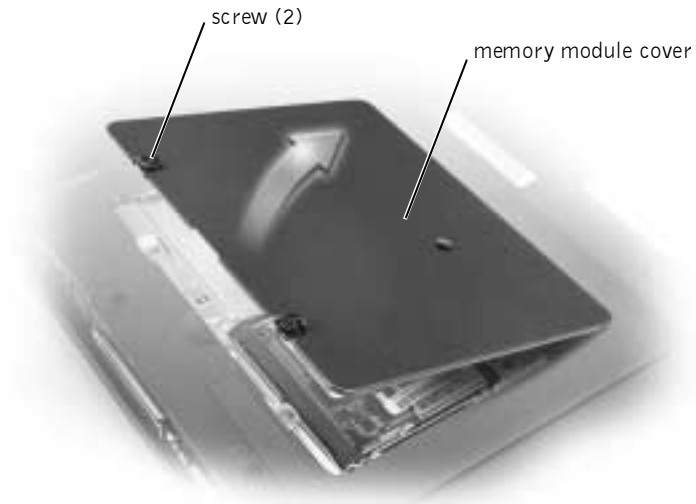

- ➔ **NOTICE:** To prevent damage to the memory module connector, do not use tools to spread the inner metal tabs that secure the memory module.
- 7 If you are replacing a memory module, remove the existing module.
- ➔ **NOTICE:** Handle memory modules by their edges, and do not touch the components on a module.
  - a Use your fingertips to carefully spread apart the securing clips on each end of the memory module connector.  
The module should pop up.
  - b Remove the module from the connector.

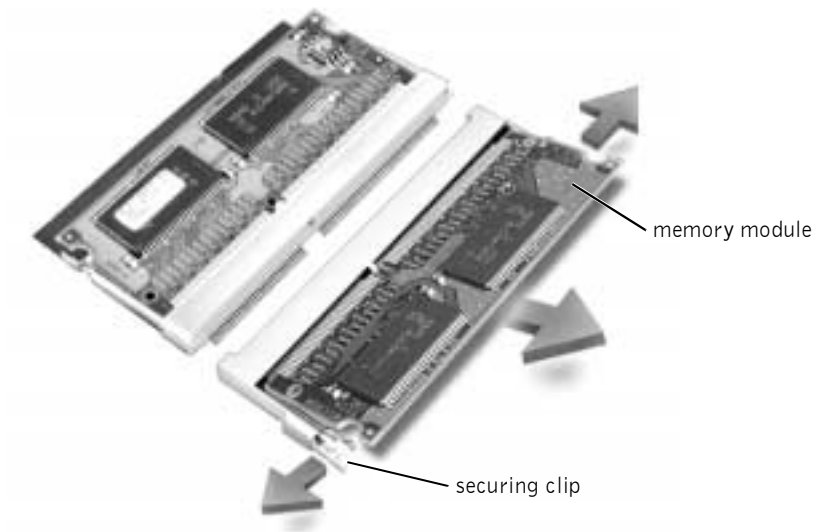

**➔ NOTICE:** If you need to install memory modules in two connectors, install a memory module in the connector labeled "JDIM (DIMMA)" before you install a module in the connector labeled "JDIM2 (DIMMB)."

**8** Ground yourself and install the new memory module:

- a** Align the notch in the module with the slot in the center of the connector.
- b** Slide the edge of the module firmly into the connector, and rotate the module down until you hear a click. If you do not hear the click, remove the module and reinstall it.

**📌 HINT:** If the memory module is not installed properly, the computer does not boot. No error message indicates this failure.



9 Replace the cover and screw(s).

➡ **NOTICE:** If the memory module cover is difficult to close, remove the module and reinstall it. Forcing the cover to close may damage your computer.

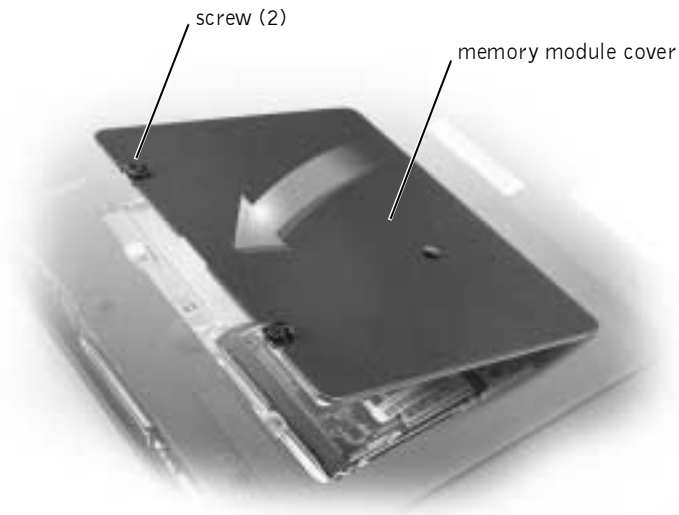

- 10** Insert the battery into the battery bay, or connect the AC adapter to your computer and an electrical outlet.
- 11** Turn on the computer.

As the computer boots, it detects the additional memory and automatically updates the system configuration information.

## Adding a Mini PCI Card

If you ordered a Mini PCI card at the same time that you ordered your computer, Dell has already installed the card for you.

- 1** Make sure that the work surface is flat and clean to prevent scratching the computer cover.
- 2** Save and close any open files, exit any open programs, and shut down the computer (see page 24).
- 3** Disconnect the computer from the electrical outlet.
- 4** Wait 10 to 20 seconds and then disconnect any attached devices.
- 5** Remove any installed PC Cards, batteries, and devices.
- 6** To ground yourself, periodically touch an unpainted metal surface on the back of the computer while you work.
- 7** Handle components and cards by their edges, and avoid touching pins and contacts.
- 8** Turn the computer over, and remove the screw from the Mini PCI card cover.
- 9** Place your finger under the cover at the indentation and lift and slide the cover open.

**10** If a Mini PCI card is not already installed, go to step 11. If you are replacing a Mini PCI card, remove the existing card:

- a** Disconnect the Mini PCI card from the antenna cables.

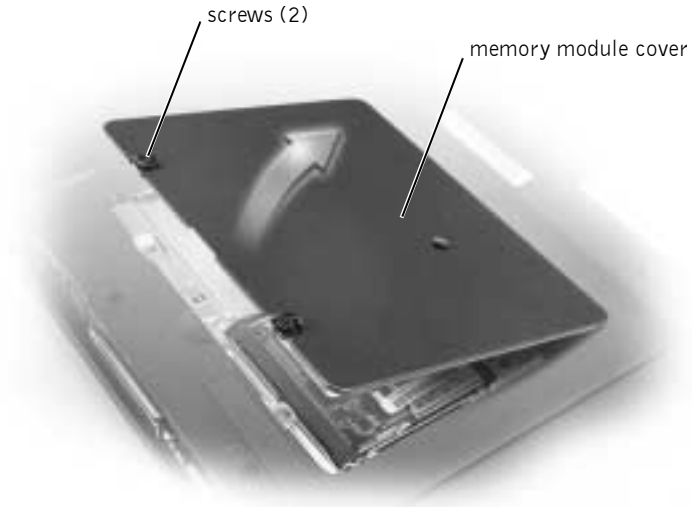

- b** To release the Mini PCI card, spread the metal securing tabs until the card pops up slightly.

- c** Lift the Mini PCI card out of its connector.

**11** Align the Mini PCI card with the socket at a 45-degree angle, and press the Mini PCI card into the socket.

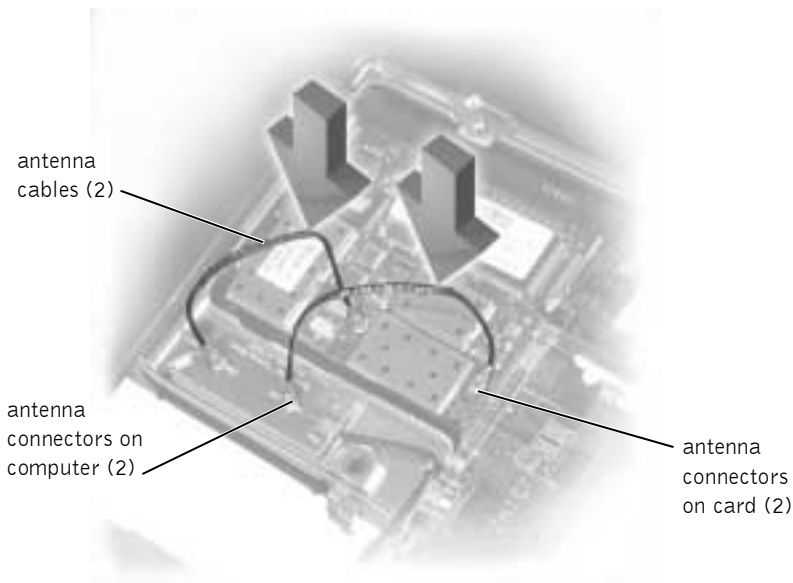

**12** Connect the antenna cables from the Mini PCI card to the antenna connectors on the computer.

**➡ NOTICE:** The connectors are keyed for correct insertion; do not force the connections.



- 13 Lower the Mini PCI card toward the inner tabs to approximately a 20-degree angle.
- 14 Continue lowering the Mini PCI card until it snaps into the inner tabs of the socket.
- 15 Replace the cover.

## Replacing the Hard Drive

-  **NOTICE:** To prevent data loss, turn off your computer (see page 24) before removing the hard drive. Do not remove the hard drive while the computer is on, in standby mode, or in hibernate mode.
-  **NOTICE:** Hard drives are extremely fragile; even a slight bump can damage the drive.
-  **CAUTION:** If you remove the hard drive from the computer when the drive is hot, *do not touch* the metal housing of the hard drive.

**HINT:** Dell does not guarantee compatibility or provide support for hard drives from sources other than Dell.

**HINT:** You need the *Operating System* CD to install the Windows® operating system. You also need the *Drivers and Utilities* CD for your computer to install the drivers and utilities on the new hard drive.

To replace the hard drive in the hard drive bay:

- 1 Save and close any open files, exit any open programs, and shut down the computer (see page 24).
- 2 Remove all installed batteries, and disconnect the AC adapter cable and any external devices from the computer.
- 3 Ground yourself by touching a metal connector on the back of the computer.
- 4 Turn the computer over. Remove the hard drive screw(s) with a small screwdriver and place the screw(s) in a safe location.

**NOTICE:** When the hard drive is not in the computer, store it in protective antistatic packaging. See "Protecting Against Electrostatic Discharge" on page 17.

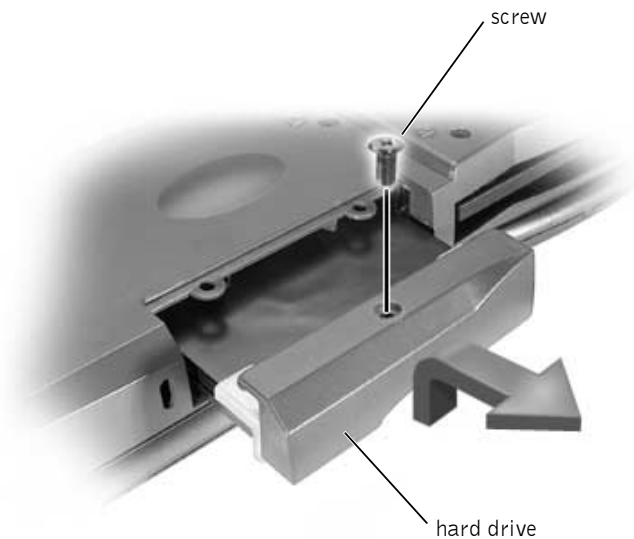

- 5 Lift up the hard drive cover until you hear a click.
- 6 Slide the hard drive out of the computer.
- 7 Remove the new drive from its packaging.

Save the original packaging to use when storing or shipping the hard drive.



- NOTICE:** Use firm and even pressure to slide the hard drive into place. If you force the drive into place using excessive force, you may damage the connector.
- 8 Push the hard drive into the hard drive bay until the drive is fully seated.
  - 9 Replace and tighten the screw(s) you removed in step 4.
  - 10 Use the *Operating System* CD to install the operating system you are using for your computer (see page 68).
  - 11 Use the *Drivers and Utilities* CD to install the drivers and utilities for your computer (see page 58).

### Returning a Hard Drive to Dell

Return your old hard drive to Dell in its original or comparable foam packaging. Otherwise, the hard drive may be damaged in transit.

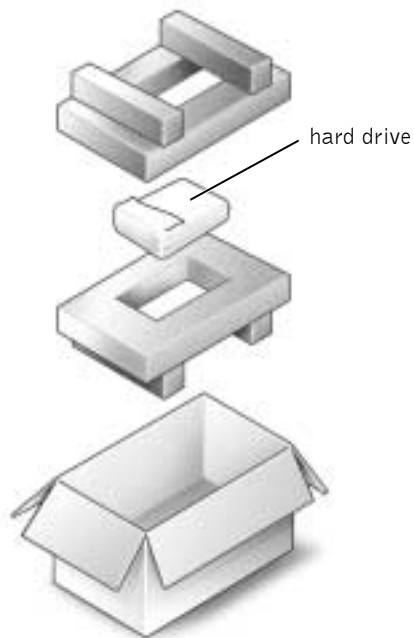

## Adding a Daughter Card Modem

If you ordered the optional modem at the same time that you ordered your computer, Dell has already installed the modem for you.

- 1** Make sure that the work surface is flat and clean to prevent scratching the computer cover.
- 2** Save and close any open files, exit any open programs, and shut down the computer (see page 24).
- 3** Disconnect the computer from the electrical outlet.
- 4** Wait 10 to 20 seconds and then disconnect any attached devices.
- 5** Remove any installed PC Cards, batteries, and devices.
- 6** To ground yourself, periodically touch an unpainted metal surface on the back of the computer while you work.
- 7** Handle components and cards by their edges, and avoid touching pins and contacts.
- 8** Turn the computer over, and remove the screws from the modem cover.
- 9** Place your finger under the cover at the indentation and lift and slide the cover open.
- 10** If a modem is not already installed, go to step 11. If you are replacing a modem, remove the existing modem:
  - a** Remove the screw(s) securing the modem to the system board, and set them aside.
  - b** Pull straight up on the attached pull tab to lift the modem out of its connector on the system board and disconnect the modem cable.

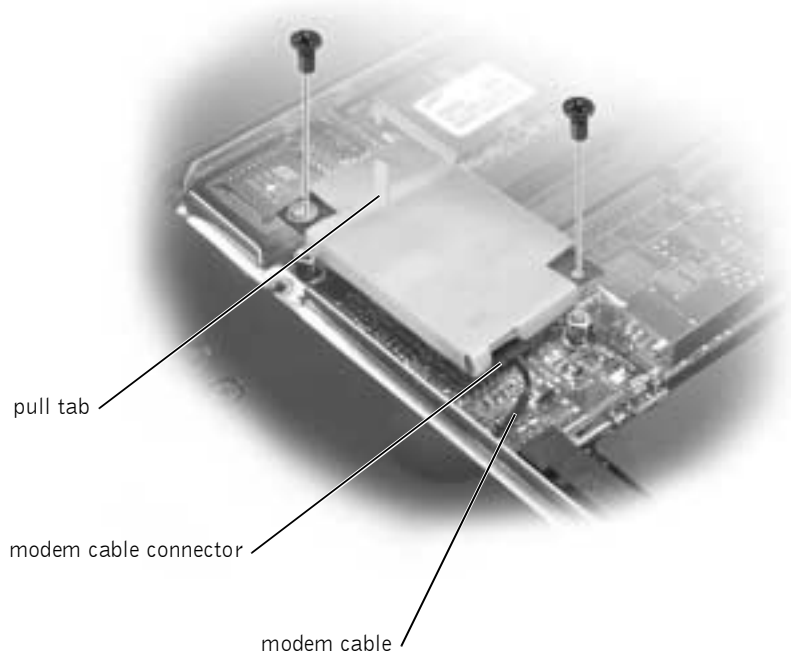

**11** Connect the modem cable to the modem.

**➡ NOTICE:** The cable connectors are keyed for correct insertion; do not force the connections.

**12** Align the modem with the screw hole(s) and press the modem into the connector on the system board.

**13** Install the screw(s) to secure the modem to the system board.

**14** Replace the modem cover.



SECTION 4

# Appendix

Specifications

Standard Settings

Returning Items for Warranty Repair or Credit

Dell Technical Support Policy (U.S. Only)

Contacting Dell

Returning Items for Warranty Repair or Credit

Limited Warranties and Return Policy

## Specifications

---

### Microprocessor

---

Microprocessor types	Intel® Mobile Pentium® III-M
L1 cache	32 KB (internal)
L2 cache	512 KB
Math coprocessor	internal to microprocessor
Processor speed	various depending on configuration
External bus frequency	133 MHz

---

### System Information

---

System chip set	Intel 830M
Data bus width	64 bits
DRAM bus width	64 bits
Microprocessor address bus width	32 bits

---

### PC Card

---

CardBus controller	Texas Instruments PCI 1420 CardBus controller
PC Card connector	two (supports two Type I or Type II cards or one Type III card)
Cards supported	3.3 V and 5 V
PC Card connector size	68 pins
Data width (maximum)	PCMCIA 16 bits CardBus 32 bits

---

## Memory

---

Architecture	PC133 SDRAM
Memory module socket	two user-accessible SODIMM sockets
Memory module capacities	64, 128, 256, and 512 MB
Memory type	3.3-V SODIMM
Standard memory	128 MB
Maximum memory	1024 MB
Memory access time: clock speed	133 MHz

---

## Ports and Connectors

---

Serial	9-pin connector; 16550C-compatible, 16-byte buffer connector
Parallel	25-hole connector; unidirectional, bidirectional, or ECP
Video	15-hole connector
Audio	microphone connector, stereo headphone/speakers connector
PS/2 keyboard/mouse	6-pin mini-DIN connector
USB	4-pin USB-compliant connector
Infrared	sensor compatible with IrDA Standard 1.1 (Fast IR) and IrDA Standard 1.0 (Slow IR)
Docking	200-pin connector for a Dell docking device
S-video TV-out	7-pin mini-DIN connector (an S-video to composite video adapter optionally included with the computer)
Mini PCI	type IIIA Mini PCI card slot with Wi-Fi (802.11b) wireless support

---

**Ports and Connectors** *(continued)*

---

Modem	RJ-11 port (optional)
Ethernet LAN	RJ-45 port (optional)

---

**Communications**

---

Modem:

Type	v.92 56K MDC
Controller	softmodem
Interface	internal AC 97 bus
Network adapter	10/100 Ethernet LOM

---

**Video**

---

Video type	128-bit hardware accelerated
Data bus	4X AGP
Video controller	ATI Mobility RADEON or NVidia GeForce2 Go-200
Video memory	16 MB or 32 MB
LCD interface	LVDS
TV support	Optional S-video to composite cable

---

**Audio**

---

Audio type	AC97 (Soft Audio)
Audio controller	Cirrus Logic CS4205
Stereo conversion	18-bit (analog-to-digital and digital-to-analog)
Interfaces:	
Internal	AC 97
External	microphone-in connector, stereo headphones/speakers connector
Speaker	two 4-ohm speakers



---

**Audio** *(continued)*

---

Internal speaker amplifier	1.0-W channel into 4 ohms
Volume controls	keyboard shortcuts, program menus

---

**Display**

---

Type (active-matrix TFT)	XGA; SXGA+; UXGA
Dimensions:	
Height	214.3 mm (8.4 inches)
Width	285.7 mm (11.3 inches)
Diagonal	357.1 mm (14.1 inches)
Maximum resolutions	1024 x 768 at 16.8 million colors (XGA), 1400 x 1050 at 16.8 million colors (SXGA+)
Response time (typical)	20-ms rise (maximum), 30-ms fall (maximum)
Operating angle	0° (closed) to 180°
Viewing angles:	
Horizontal	±40°
Vertical	+10°/-30°
Pixel pitch	0.279 x 0.279 mm (XGA) 0.204 x 0.204 mm (SXGA+)
Power Consumption:	
Panel with backlight (typical)	6.5 W (XGA) 7.0 W (SXGA+)
Controls	brightness can be controlled through keyboard shortcuts

---

**Keyboard**

---

Number of keys	87 (U.S. and Canada); 88 (Europe); 91 (Japan)
Key travel	2.7 mm ± 0.3 (0.11 inch ± 0.016 inch)

---

**Keyboard** *(continued)*

---

Key spacing	19.05 mm ± 0.3 mm (0.75 inch ± 0.012 inch)
Layout	QWERTY/AZERTY/Kanji

---

**Touch Pad**

---

X/Y position resolution (graphics table mode)	240 cpi
Size:	
Width	64.88 mm (2.55-inch) sensor-active area
Height	48.88-mm (1.92-inch) rectangle

---

**Track Stick**

---

X/Y position resolution (graphics table mode)	250 count/sec @ 100 gf
Size	protrudes 0.5 mm higher than surrounding key caps

---

**Battery**

---

Type	8-cell "smart" lithium ion (59 WHr) 4-cell "smart" lithium ion (26.5 WHr)
Dimensions:	
Depth	88.5 mm (3.48 inches)
Height	21.5 mm (0.83 inch)
Width	139.0 mm (5.47 inches)
Weight	0.40 kg (0.88 lb) (8 cell) 0.26 kg (0.57 lb) (4 cell)
Voltage	14.8 VDC
Charge time (approximate):	
Computer on	2.5 hours
Computer off	1 hour
Operating life	approximately 2 to 4 hours with 8-cell battery

---

**Battery** *(continued)*

---

Life span (approximate)	500 discharge/charge cycles
Temperature range:	
Operating	0° to 35°C (32° to 95°F)
Storage	-40° to 65°C (-40° to 149°F)

---

**AC Adapter**

---

Input voltage	90 to 264 VAC
Input current (maximum)	1.7 A
Input frequency	47 to 63 Hz
Output current	4.5 A (maximum at 4-second pulse); 3.5 A (continuous)
Output power	70 W
Rated output voltage	19.5 VDC
Dimensions:	
Height	27.94 mm (1.1 inches)
Width	58.42 mm (2.3 inches)
Depth	133.85 mm (5.25 inches)
Weight (with cables)	0.4 kg (0.9 lb)
Temperature range:	
Operating	0° to 35°C (32° to 95°F)
Storage	-40° to 65°C (-40° to 149°F)

---

**Physical**

---

Height	36.8 mm (1.4 inches)
Width	319.5 mm (12.5 inches)
Depth	253.6 mm (9.9 inches)

---

**Physical** *(continued)*

---

Weight (with 8-cell battery):	2.4 kg (5.3 lb) with travel module
	2.6 kg (5.7 lb) with floppy drive
	2.6 kg (5.8 lb) with CD drive

---

**Environmental**

---

## Temperature range:

Operating	0° to 35°C (32° to 95°F)
Storage	-40° to 65°C (-40° to 149°F)

## Relative humidity (maximum):

Operating	10% to 90% (noncondensing)
Storage	5% to 95% (noncondensing)

## Maximum vibration:

Operating	0.9 GRMS using a random-vibration spectrum that simulates user environment
Storage	1.3 GRMS using a random-vibration spectrum that simulates air/truck shipment

## Maximum shock:

Operating	122 G (2 msec shock pulse) with HDD head parked
Storage	163 G (2 msec shock pulse) with HDD head parked

## Altitude (maximum):

Operating	-15.2 to 3048 m (-50 to 10,000 ft)
Storage	-15.2 to 10,668 m (-50 to 35,000 ft)

# Standard Settings

The system setup program contains the standard settings for your computer.



**NOTICE:** Unless you are an expert computer user or are directed to do so by Dell technical support, do not change the settings for this program. Certain changes might make your computer work incorrectly.

## Viewing the System Setup Screens

- 1 Turn on (or restart) your computer.
- 2 When the Dell™ logo appears, press <F2> immediately.

If you wait too long and the Microsoft® Windows® logo appears, continue to wait until you see the Windows desktop. Then shut down your computer (see page 24) and try again.



**HINT:** Depending on your computer, you may also be able to start the system setup program by pressing the <Fn><F1> keyboard shortcut at any time while the computer is running.

## System Setup Screens

The system setup screens display the current setup information and settings for your computer. Each screen is laid out with the system setup options listed at the left. To the right of each option is a field that displays the setting or value for that option. You can change settings that appear as white type on the screen. Options or values that you cannot change (because they are determined by the computer) appear less bright.

A box in the upper-right corner of the screen displays help information for the currently highlighted option; a box in the lower-right corner displays information about the computer. System setup key functions are listed across the bottom of the screen.



**HINT:** To see information about a specific item on a system setup screen, highlight the item and refer to the **Help** area on the screen.

The screens display such information as:

- System configuration
- Boot configuration and dock configuration settings
- Basic device configuration settings
- Battery charge status
- Power management settings
- System security and hard drive password settings

## Returning Items for Warranty Repair or Credit

Prepare all items being returned, whether for repair or credit, as follows:

- 1 Call Dell to obtain an authorization number, and write it clearly and prominently on the outside of the box.  
For the telephone number to call, see the contact numbers for your region.
- 2 Include a copy of the invoice and a letter describing the reason for the return.
- 3 Include any accessories that belong with the item(s) being returned (power cables, software diskettes, guides, and so on) if the return is for credit.
- 4 Pack the equipment to be returned in the original (or equivalent) packing materials.

You are responsible for paying shipping expenses. You are also responsible for insuring any product returned, and you assume the risk of loss during shipment to Dell. Collect On Delivery (C.O.D.) packages are not accepted.

Returns that are missing any of the preceding requirements will be refused at our receiving dock and returned to you.

## Dell Technical Support Policy (U.S. Only)

Technician-assisted technical support requires the cooperation and participation of the customer in the troubleshooting process and provides for restoration of the operating system, application software, and hardware drivers to the original default configuration as shipped from Dell, as well as the verification of appropriate functionality of the computer and all Dell-installed hardware. In addition to this technician-assisted technical support, online technical support is available at [support.dell.com](http://support.dell.com). Additional technical support options may be available for purchase.

Dell provides limited technical support for the computer and any "Dell-installed" software and peripherals<sup>1</sup>. Support for third-party software and peripherals is provided by the original manufacturer, including those purchased and/or installed through Dell Software & Peripherals (DellWare™), Readyware, and Custom Factory Integration (DellPlus™)<sup>2</sup>.

- <sup>1</sup> Repair services are provided pursuant to the terms and conditions of your limited warranty and any optional support service contract purchased with the computer.
- <sup>2</sup> All Dell-standard components included in a Custom Factory Integration (CFI) project are covered by the standard Dell limited warranty for your computer. However, Dell also extends a parts replacement program to cover all nonstandard, third-party hardware components integrated through CFI for the duration of the computer's service contract.

### **Definition of "Dell-Installed" Software and Peripherals**

Dell-installed software includes the operating system and some of the application software that is preinstalled on the computer during the manufacturing process (Microsoft Office, Norton Antivirus, and so on).

Dell-installed peripherals include any internal expansion cards, or Dell-branded module bay or PC Card accessories. In addition, any Dell-branded monitors, keyboards, mice, speakers, microphones for telephonic modems, docking stations/port replicators, networking products, and all associated cabling are included.

### **Definition of "Third-Party" Software and Peripherals**

Third-party software and peripherals include any peripheral, accessory, or application software sold by Dell not under the Dell brand (printers, scanners, cameras, games, and so on). Support for all third-party software and peripherals is provided by the original manufacturer of the product.

## **Contacting Dell**

When you need to contact Dell, use the telephone numbers, codes, and electronic addresses provided in the following table. If you need assistance in determining which codes to use, contact a local or an international operator.



**HINT:** Toll-free numbers are for use within the country for which they are listed.

See "Dell Technical Support Policy (U.S. Only)" on page 100 for a description of the hardware and software support provided by Dell.

<b>Country (City) International Access Code Country Code City Code</b>	<b>Department Name or Service Area, Website and E-mail Address</b>	<b>Area Codes, Local Numbers, and Toll Free Numbers</b>
Antigua and Barbuda	General Support	1-800-805-5924
Australia (Sydney)	Home and Small Business	1-300-65-55-33
International Access Code: 0011	Government and Business	toll free: 1-800-633-559
Country Code: 61	Preferred Accounts Division (PAD)	toll free: 1-800-060-889
City Code: 2	Customer Care	toll free: 1-800-819-339
	Corporate Sales	toll free: 1-800-808-385
	Transaction Sales	toll free: 1-800-808-312
	Fax	toll free: 1-800-818-341
Austria (Vienna)	Home/Small Business Sales	01 795 67602
International Access Code: 900	Home/Small Business Fax	01 795 67605
Country Code: 43	Home/Small Business Customer Care	01 795 67603
City Code: 1	Preferred Accounts/Corporate Customer Care	0660 8056
	Home/Small Business Technical Support	01 795 67604
	Preferred Accounts/Corporate Technical Support	0660 8779
	Switchboard	01 491 04 0
	Website: <a href="http://support.euro.dell.com">http://support.euro.dell.com</a>	
	E-mail: <a href="mailto:tech_support_central_europe@dell.com">tech_support_central_europe@dell.com</a>	
Barbados	General Support	1-800-534-3066
Belgium (Brussels)	Technical Support	02 481 92 88
International Access Code: 00	Customer Care	02 481 91 19
Country Code: 32	Home/Small Business Sales	toll free: 0800 16884
City Code: 2	Corporate Sales	02 481 91 00
	Fax	02 481 92 99
	Switchboard	02 481 91 00
	Website: <a href="http://support.euro.dell.com">http://support.euro.dell.com</a>	
	E-mail: <a href="mailto:tech_be@dell.com">tech_be@dell.com</a>	
	E-mail for French Speaking Customers: <a href="http://support.euro.dell.com/be/fr/emaildell/">http://support.euro.dell.com/be/fr/emaildell/</a>	
Bermuda	General Support	1-800-342-0671



<b>Country (City) International Access Code Country Code City Code</b>	<b>Department Name or Service Area, Website and E-mail Address</b>	<b>Area Codes, Local Numbers, and Toll Free Numbers</b>
<b>Brazil</b>	Customer Support, Technical Support	0800 90 3355
International Access Code: 0021	Tech Support Fax	55 51 481 5470
Country Code: 55	Sales	0800 90 3366
City Code: 51	Website: <a href="http://www.dell.com/br">http://www.dell.com/br</a>	
<b>Brunei</b>	Customer Technical Support (Penang, Malaysia)	604 633 4966
Country Code: 673	Customer Service (Penang, Malaysia)	604 633 4949
	Transaction Sales (Penang, Malaysia)	604 633 4955
<b>Canada (North York, Ontario)</b>	Automated Order-Status System	toll free: 1-800-433-9014
International Access Code: 011	AutoTech (Automated technical support)	toll free: 1-800-247-9362
	Customer Care (From outside Toronto)	toll free: 1-800-387-5759
	Customer Care (From within Toronto)	416 758-2400
	Customer Technical Support	toll free: 1-800-847-4096
	Sales (Direct Sales—from outside Toronto)	toll free: 1-800-387-5752
	Sales (Direct Sales—from within Toronto)	416 758-2200
	Sales (Federal government, education, and medical)	toll free: 1-800-567-7542
	Sales (Major Accounts)	toll free: 1-800-387-5755
	TechFax	toll free: 1-800-950-1329
<b>Cayman Islands</b>	General Support	1-800-805-7541
<b>Chile (Santiago)</b>	Sales, Customer Support, and Technical Support	toll free: 1230-020-4823
Country Code: 56		
City Code: 2		

<b>Country (City) International Access Code Country Code City Code</b>	<b>Department Name or Service Area, Website and E-mail Address</b>	<b>Area Codes, Local Numbers, and Toll Free Numbers</b>
<b>China (Xiamen)</b> Country Code: 86 City Code: 592	Home and Small Business Technical Support	toll free: 800 858 2437
	Corporate Accounts Technical Support	toll free: 800 858 2333
	Customer Experience	toll free: 800 858 2060
	Home and Small Business	toll free: 800 858 2222
	Preferred Accounts Division	toll free: 800 858 2062
	Large Corporate Accounts North	toll free: 800 858 2999
	Large Corporate Accounts East	toll free: 800 858 2020
	Large Corporate Accounts South	toll free: 800 858 2355
	Large Corporate Accounts GCP	toll free: 800 858 2055
	Large Corporate Accounts HK	toll free: 800 964108
Large Corporate Accounts GCP HK	toll free: 800 907308	
<b>Colombia</b>	General Support	980-9-15-3978
<b>Costa Rica</b>	General Support	0800-012-0435
<b>Czech Republic (Prague)</b> International Access Code: 00 Country Code: 420 City Code: 2	Technical Support	02 22 83 27 27
	Customer Care	02 22 83 27 11
	Fax	02 22 83 27 14
	TechFax	02 22 83 27 28
	Switchboard	02 22 83 27 11
	Website: <a href="http://support.euro.dell.com">http://support.euro.dell.com</a>	
	E-mail: <a href="mailto:czech_dell@dell.com">czech_dell@dell.com</a>	
<b>Denmark (Horsholm)</b> International Access Code: 00 Country Code: 45	Technical Support	45170182
	Relational Customer Care	45170184
	Home/Small Business Customer Care	32875505
	Switchboard	45170100
	Fax Technical Support (Upplands Vasby, Sweden)	46 0 859005594
	Fax Switchboard	45170117
	Website: <a href="http://support.euro.dell.com">http://support.euro.dell.com</a>	
	E-mail: <a href="mailto:den_support@dell.com">den_support@dell.com</a>	
E-mail Support for Servers: <a href="mailto:Nordic_server_support@dell.com">Nordic_server_support@dell.com</a>		

<b>Country (City) International Access Code Country Code City Code</b>	<b>Department Name or Service Area, Website and E-mail Address</b>	<b>Area Codes, Local Numbers, and Toll Free Numbers</b>
Dominican Republic	General Support	1-800-148-0530
El Salvador	General Support	01-899-753-0777
Finland (Helsinki)	Technical Support	09 253 313 60
International Access Code: 990	Technical Support Fax	09 253 313 81
Country Code: 358	Relational Customer Care	09 253 313 38
City Code: 9	Home/Small Business Customer Care	09 693 791 94
	Fax	09 253 313 99
	Switchboard	09 253 313 00
	Website: <a href="http://support.euro.dell.com">http://support.euro.dell.com</a>	
	E-mail: <a href="mailto:fin_support@dell.com">fin_support@dell.com</a>	
France (Paris/Montpellier)	<b>Home and Small Business</b>	
International Access Code: 00	Technical Support	0825 387 270
Country Code: 33	Customer Care	0825 823 833
City Code: (1) (4)	Switchboard	0825 004 700
	Switchboard (Alternative)	04 99 75 40 00
	Sales	0825 004 700
	Fax	0825 004 701
	Fax (Alternative)	04 99 75 40 01
	Website: <a href="http://support.euro.dell.com">http://support.euro.dell.com</a>	
	E-mail: <a href="http://support.euro.dell.com/fr/fr/emaildell/">http://support.euro.dell.com/fr/fr/emaildell/</a>	
	<b>Corporate</b>	
	Technical Support	0825 004 719
	Customer Care	0825 338 339
	Switchboard	01 55 94 71 00
	Sales	01 55 94 71 00
	Fax	01 55 94 71 01
	Website: <a href="http://support.euro.dell.com">http://support.euro.dell.com</a>	
	E-mail: <a href="http://support.euro.dell.com/fr/fr/emaildell/">http://support.euro.dell.com/fr/fr/emaildell/</a>	

<b>Country (City) International Access Code Country Code City Code</b>	<b>Department Name or Service Area, Website and E-mail Address</b>	<b>Area Codes, Local Numbers, and Toll Free Numbers</b>
<b>Germany (Langen)</b>	Technical Support	06103 766-7200
International Access Code: 00	Home/Small Business Customer Care	0180-5-224400
Country Code: 49	Global Segment Customer Care	06103 766-9570
City Code: 6103	Preferred Accounts Customer Care	06103 766-9420
	Large Accounts Customer Care	06103 766-9560
	Public Accounts Customer Care	06103 766-9555
	Switchboard	06103 766-7000
	Website: <a href="http://support.euro.dell.com">http://support.euro.dell.com</a>	
	E-mail: <a href="mailto:tech_support_central_europe@dell.com">tech_support_central_europe@dell.com</a>	
<b>Guatemala</b>	General Support	1-800-999-0136
<b>Hong Kong</b>	Technical Support	toll free: 800 96 4107
International Access Code: 001	Customer Service (Penang, Malaysia)	604 633 4949
Country Code: 852	Transaction Sales	toll free: 800 96 4109
	Corporate Sales	toll free: 800 96 4108
<b>Ireland (Cherrywood)</b>	Technical Support	0870 908 0800
International Access Code: 16	Home User Customer Care	01 204 4095
Country Code: 353	Small Business Customer Care	01 204 4026
City Code: 1	Corporate Customer Care	01 204 4003
	Sales	01 286 0500
	SalesFax	01 204 0144
	Fax	0870 907 5590
	Switchboard	01 286 0500
	Website: <a href="http://support.euro.dell.com">http://support.euro.dell.com</a>	
	E-mail: <a href="mailto:dell_direct_support@dell.com">dell_direct_support@dell.com</a>	

<b>Country (City) International Access Code Country Code City Code</b>	<b>Department Name or Service Area, Website and E-mail Address</b>	<b>Area Codes, Local Numbers, and Toll Free Numbers</b>
<b>Italy (Milan)</b>	<b>Home and Small Business</b>	
International Access Code: 00	Technical Support	02 577 826 90
Country Code: 39	Customer Care	02 696 821 14
City Code: 02	Fax	02 696 821 13
	Switchboard	02 696 821 12
	Website: <a href="http://support.euro.dell.com">http://support.euro.dell.com</a>	
	E-mail: <a href="http://support.euro.dell.com/it/it/emaildell/">http://support.euro.dell.com/it/it/emaildell/</a>	
	<b>Corporate</b>	
	Technical Support	02 577 826 90
	Customer Care	02 577 825 55
	Fax	02 575 035 30
	Switchboard	02 577 821
	Website: <a href="http://support.euro.dell.com">http://support.euro.dell.com</a>	
	E-mail: <a href="http://support.euro.dell.com/it/it/emaildell/">http://support.euro.dell.com/it/it/emaildell/</a>	
<b>Jamaica</b>	General Support	1-800-682-3639

<b>Country (City) International Access Code Country Code City Code</b>	<b>Department Name or Service Area, Website and E-mail Address</b>	<b>Area Codes, Local Numbers, and Toll Free Numbers</b>
Japan (Kawasaki) International Access Code: 001 Country Code: 81 City Code: 44	Technical Support (Server)	toll free: 0120-1984-35
	Technical Support Outside of Japan (Server)	81-44-556-4152
	Technical Support (Dimension™ and Inspiron™)	toll free: 0120-1982-26
	Technical Support Outside of Japan (Dimension and Inspiron)	81-44-520-1435
	Technical Support (Dell Precision™, OptiPlex™ and Latitude™)	toll free: 0120-1984-33
	Technical Support Outside of Japan (Dell Precision, OptiPlex, and Latitude)	81-44-556-3894
	24-Hour Automated Order Service	044 556-3801
	Customer Care	044 556-4240
	Business Sales Division (up to 400 employees)	044 556 3494
	Preferred Accounts Division Sales (over 400 employees)	044 556-3433
	Large Corporate Accounts Sales (over 3500 employees)	044 556-3440
	Public Sales (Government Agencies, Educational Institutions, and Medical Institutions)	044 556 3440
	Global Segment Japan	044 556 3469
	Individual User	044 556 1657
Faxbox Service	044 556-3490	
Switchboard	044 556-4300	
Website: <a href="http://support.jp.dell.com">http://support.jp.dell.com</a>		
Korea (Seoul) International Access Code: 001 Country Code: 82 City Code: 2	Technical Support	toll free: 080-200-3800
	Sales	toll free: 080-200-3600
	Customer Service (Seoul, Korea)	toll free: 080-200-3800
	Customer Service (Penang, Malaysia)	604 633 4949
	Fax	2194-6202
Switchboard	2194-6000	

<b>Country (City) International Access Code Country Code City Code</b>	<b>Department Name or Service Area, Website and E-mail Address</b>	<b>Area Codes, Local Numbers, and Toll Free Numbers</b>
<b>Latin America</b>	Customer Technical Support (Austin, Texas, U.S.A.)	512 728-4093
	Customer Service (Austin, Texas, U.S.A.)	512 728-3619
	Fax (Technical Support and Customer Service) (Austin, Texas, U.S.A.)	512 728-3883
	Sales (Austin, Texas, U.S.A.)	512 728-4397
	SalesFax (Austin, Texas, U.S.A.)	512 728-4600 or 512 728-3772
<b>Luxembourg</b> International Access Code: 00 Country Code: 352	Technical Support (Brussels, Belgium)	02 481 92 88
	Home/Small Business Sales (Brussels, Belgium)	toll free: 080016884
	Corporate Sales (Brussels, Belgium)	02 481 91 00
	Customer Care (Brussels, Belgium)	02 481 91 19
	Fax (Brussels, Belgium)	02 481 92 99
	Switchboard (Brussels, Belgium)	02 481 91 00
	Website: <a href="http://support.euro.dell.com">http://support.euro.dell.com</a> E-mail: tech_be@dell.com	
<b>Macau</b> Country Code: 853	Technical Support	toll free: 0800 582
	Customer Service (Penang, Malaysia)	604 633 4949
	Transaction Sales	toll free: 0800 581
<b>Malaysia (Penang)</b> International Access Code: 00 Country Code: 60 City Code: 4	Technical Support	toll free: 1 800 888 298
	Customer Service	04 633 4949
	Transaction Sales	toll free: 1 800 888 202
	Corporate Sales	toll free: 1 800 888 213

<b>Country (City) International Access Code Country Code City Code</b>	<b>Department Name or Service Area, Website and E-mail Address</b>	<b>Area Codes, Local Numbers, and Toll Free Numbers</b>
Mexico International Access Code: 00 Country Code: 52	Customer Technical Support  Sales  Customer Service  Main	001-877-384-8979 or 001-877-269-3383 50-81-8800 or 01-800-888-3355 001-877-384-8979 or 001-877-269-3383 50-81-8800 or 01-800-888-3355
<b>Netherlands Antilles</b>	General Support	001-800-882-1519
<b>Netherlands (Amsterdam)</b> International Access Code: 00 Country Code: 31 City Code: 20	Technical Support Customer Care Home/Small Business Sales Home/Small Business Sales Fax Corporate Sales Corporate Sales Fax Fax Switchboard Website: <a href="http://support.euro.dell.com">http://support.euro.dell.com</a> E-mail: <a href="mailto:tech_nl@dell.com">tech_nl@dell.com</a>	020 581 8838 020 581 8740 toll free: 0800-0663 020 682 7171 020 581 8818 020 686 8003 020 686 8003 020 581 8818
<b>New Zealand</b> International Access Code: 00 Country Code: 64	Home and Small Business Government and Business Sales Fax	0800 446 255 0800 444 617 0800 441 567 0800 441 566
<b>Nicaragua</b>	General Support	001-800-220-1006



<b>Country (City) International Access Code Country Code City Code</b>	<b>Department Name or Service Area, Website and E-mail Address</b>	<b>Area Codes, Local Numbers, and Toll Free Numbers</b>
Norway (Lysaker)	Technical Support	671 16882
International Access Code: 00	Relational Customer Care	671 17514
Country Code: 47	Home/Small Business Customer Care	23162298
	Switchboard	671 16800
	Fax Technical Support (Upplands Vasby, Sweden)	46 0 85 590 05 594
	Fax Switchboard	671 16865
	Website: <a href="http://support.euro.dell.com">http://support.euro.dell.com</a>	
	E-mail: <a href="mailto:nor_support@dell.com">nor_support@dell.com</a>	
	E-mail Support for Servers: <a href="mailto:Nordic_server_support@dell.com">Nordic_server_support@dell.com</a>	
<b>Panama</b>	General Support	001-800-507-0962
<b>Peru</b>	General Support	0800-50-669
<b>Poland (Warsaw)</b>	Customer Service Phone	57 95 700
International Access Code: 011	Customer Care	57 95 999
Country Code: 48	Sales	57 95 999
City Code: 22	Customer Service Fax	57 95 806
	Reception Desk Fax	57 95 998
	Switchboard	57 95 999
	Website: <a href="http://support.euro.dell.com">http://support.euro.dell.com</a>	
	E-mail: <a href="mailto:pl_support@dell.com">pl_support@dell.com</a>	
<b>Portugal</b>	Technical Support	35 800 834 077
International Access Code: 00	Customer Care	800 300 415 or 35 800 834 075
Country Code: 35	Sales	800 300 410 or 800 300 411 or 800 300 412 or 351 214 220 710
	Fax	35 121 424 01 12
	E-mail: <a href="http://support.euro.dell.com/es/es/emaildell/">http://support.euro.dell.com/es/es/emaildell/</a>	
<b>Puerto Rico</b>	General Support	1-800-805-7545

<b>Country (City) International Access Code Country Code City Code</b>	<b>Department Name or Service Area, Website and E-mail Address</b>	<b>Area Codes, Local Numbers, and Toll Free Numbers</b>
<b>St. Lucia</b>	General Support	1-800-882-1521
<b>Singapore (Singapore)</b>	Technical Support	toll free: 800 6011 051
International Access Code: 005	Customer Service (Penang, Malaysia)	604 633 4949
Country Code: 65	Transaction Sales	toll free: 800 6011 054
	Corporate Sales	toll free: 800 6011 053
<b>South Africa (Johannesburg)</b>	Technical Support	011 709 7710
International Access Code: 09/091	Customer Care	011 709 7707
	Sales	011 709 7700
Country Code: 27	Fax	011 706 0495
City Code: 11	Switchboard	011 709 7700
	Website: <a href="http://support.euro.dell.com">http://support.euro.dell.com</a>	
	E-mail: <a href="mailto:dell_za_support@dell.com">dell_za_support@dell.com</a>	
<b>Southeast Asian and Pacific Countries</b>	Customer Technical Support, Customer Service, and Sales (Penang, Malaysia)	604 633 4810
<b>Spain (Madrid)</b>	<b>Home and Small Business</b>	
International Access Code: 00	Technical Support	902 100 130
Country Code: 34	Customer Care	902 118 540
City Code: 91	Sales	902 118 541
	Switchboard	902 118 541
	Fax	902 118 539
	Website: <a href="http://support.euro.dell.com">http://support.euro.dell.com</a>	
	E-mail: <a href="http://support.euro.dell.com/es/es/emaildell/">http://support.euro.dell.com/es/es/emaildell/</a>	
	<b>Corporate</b>	
	Technical Support	902 100 130
	Customer Care	902 118 546
	Switchboard	91 722 92 00
	Fax	91 722 95 83
	Website: <a href="http://support.euro.dell.com">http://support.euro.dell.com</a>	
	E-mail: <a href="http://support.euro.dell.com/es/es/emaildell/">http://support.euro.dell.com/es/es/emaildell/</a>	

<b>Country (City) International Access Code Country Code City Code</b>	<b>Department Name or Service Area, Website and E-mail Address</b>	<b>Area Codes, Local Numbers, and Toll Free Numbers</b>
Sweden (Upplands Vasby)	Technical Support	08 590 05 199
International Access Code: 00	Relational Customer Care	08 590 05 642
Country Code: 46	Home/Small Business Customer Care	08 587 70 527
City Code: 8	Fax Technical Support	08 590 05 594
	Sales	08 590 05 185
	Website: <a href="http://support.euro.dell.com">http://support.euro.dell.com</a>	
	E-mail: <a href="mailto:swe_support@dell.com">swe_support@dell.com</a>	
	E-mail Support for Latitude and Inspiron: <a href="mailto:Swe-nbk_kats@dell.com">Swe-nbk_kats@dell.com</a>	
	E-mail Support for OptiPlex: <a href="mailto:Swe_kats@dell.com">Swe_kats@dell.com</a>	
	E-mail Support for Servers: <a href="mailto:Nordic_server_support@dell.com">Nordic_server_support@dell.com</a>	
Switzerland (Geneva)	Technical Support (Home and Small Business)	0844 811 411
International Access Code: 00	Technical Support (Corporate)	0844 822 844
Country Code: 41	Customer Care (Home and Small Business)	0848 802 202
City Code: 22	Customer Care (Corporate)	0848 821 721
	Fax	022 799 01 90
	Switchboard	022 799 01 01
	Website: <a href="http://support.euro.dell.com">http://support.euro.dell.com</a>	
	E-mail: <a href="mailto:swisstech@dell.com">swisstech@dell.com</a>	
	E-mail for French Speaking HSB and Corporate Customers: <a href="http://support.euro.dell.com/ch/fr/emaildell/">http://support.euro.dell.com/ch/fr/emaildell/</a>	
Taiwan	Technical Support	toll free: 0080 60 1255
International Access Code: 002	Technical Support (Servers)	toll free: 0080 60 1256
Country Code: 886	Transaction Sales	toll free: 0080 651 228 or 0800 33 556
	Corporate Sales	toll free: 0080 651 227 or 0800 33 555

<b>Country (City) International Access Code Country Code City Code</b>	<b>Department Name or Service Area, Website and E-mail Address</b>	<b>Area Codes, Local Numbers, and Toll Free Numbers</b>
<b>Thailand</b>	Technical Support	toll free: 0880 060 07
International Access Code: 001	Customer Service (Penang, Malaysia)	604 633 4949
Country Code: 66	Sales	toll free: 0880 060 09
<b>Trinidad/Tabago</b>	General Support	1-800-805-8035
<b>U.K. (Bracknell)</b>	Technical Support (Corporate/Preferred Accounts/PAD [1000+ employees])	0870 908 0500
International Access Code: 010	Technical Support (Direct/PAD and General)	0870 908 0800
Country Code: 44	Global Accounts Customer Care	01344 723186
City Code: 1344	Home and Small Business Customer Care	0870 906 0010
	Corporate Customer Care	0870 908 0500
	Preferred Accounts (500-5000 employees) Customer Care	01344 723196
	Central Government Customer Care	01344 723193
	Local Government Customer Care	01344 723194
	Home/Small Business Sales	0870 907 4000
	Corporate/Public Sector Sales	01344 860456
	Website: <a href="http://support.euro.dell.com">http://support.euro.dell.com</a>	
	E-mail: <a href="mailto:dell_direct_support@dell.com">dell_direct_support@dell.com</a>	

<b>Country (City) International Access Code Country Code City Code</b>	<b>Department Name or Service Area, Website and E-mail Address</b>	<b>Area Codes, Local Numbers, and Toll Free Numbers</b>
U.S.A. (Austin, Texas)	Automated Order-Status System	toll free: 1-800-433-9014
International Access Code: 011 Country Code: 1	AutoTech (for portable and desktop computers)	toll free: 1-800-247-9362
	<b>Dell Home and Small Business Group</b> (for portable and desktop computers):	
	Customer Technical Support (Return Material Authorization Numbers)	toll free: 1-800-624-9896
	Customer Technical Support (Home sales purchased via <a href="http://www.dell.com">http://www.dell.com</a> )	toll free: 1-877-576-3355
	Customer Service (Credit Return Authorization Numbers)	toll free: 1-800-624-9897
	<b>National Accounts</b> (systems purchased by established Dell national accounts [have your account number handy], medical institutions, or value-added resellers [VARs]):	
	Customer Service and Technical Support (Return Material Authorization Numbers)	toll free: 1-800-822-8965
	<b>Public Americas International</b> (systems purchased by governmental agencies [local, state, or federal] or educational institutions):	
	Customer Service and Technical Support (Return Material Authorization Numbers)	toll free: 1-800-234-1490
	Dell Sales	toll free: 1-800-289-3355 or toll free: 1-800-879-3355
	Spare Parts Sales	toll free: 1-800-357-3355
	DellWare™	toll free: 1-800-753-7201
	Desktop and Portable Fee-Based Technical Support	toll free: 1-800-433-9005
	Server Fee-Based Technical Support	toll free: 1-800-967-0765
	Sales (Catalogs)	toll free: 1-800-426-5150
	Fax	toll free: 1-800-727-8320
	TechFax	toll free: 1-800-950-1329
	Dell Services for the Deaf, Hard-of-Hearing, or Speech-Impaired	toll free: 1-877-DELLTY (1-877-335-5889)
	Switchboard	512 338-4400
	DellNet™ Technical Support	toll free: 1-877-Dellnet (1-877-335-5638)

<b>Country (City) International Access Code Country Code City Code</b>	<b>Department Name or Service Area, Website and E-mail Address</b>	<b>Area Codes, Local Numbers, and Toll Free Numbers</b>
US Virgin Islands	General Support	1-877-673-3355
Venezuela	General Support	8001-3605

## Returning Items for Warranty Repair or Credit

Prepare all items being returned, whether for repair or credit, as follows:

- 1 Call Dell to obtain an authorization number, and write it clearly and prominently on the outside of the box.  
For the telephone number to call, see the contact numbers for your region.
- 2 Include a copy of the invoice and a letter describing the reason for the return.
- 3 Include any accessories that belong with the item(s) being returned (power cables, software diskettes, guides, and so on) if the return is for credit.
- 4 Pack the equipment to be returned in the original (or equivalent) packing materials.

You are responsible for paying shipping expenses. You are also responsible for insuring any product returned, and you assume the risk of loss during shipment to Dell. Collect On Delivery (C.O.D.) packages are not accepted.

Returns that are missing any of the preceding requirements will be refused at our receiving dock and returned to you.

## Regulatory Information

Additional regulatory information regarding your computer can be found in the *Tell Me How* help file. To access the *Tell Me How* help file, see page 34.

## **FCC Notices (U.S. Only)**

Most Dell computers are classified by the Federal Communications Commission (FCC) as Class B digital devices. To determine which classification applies to your computer, examine all FCC registration labels located on the bottom or back panel of your computer, on card-mounting brackets, and on the cards themselves. If any one of the labels carries a Class A rating, your entire computer is considered to be a Class A digital device. If *all* labels carry an FCC Class B rating as distinguished by either an FCC ID number or the FCC logo, (FCC), your computer is considered to be a Class B digital device.

Once you have determined your computer's FCC classification, read the appropriate FCC notice. Note that FCC regulations provide that changes or modifications not expressly approved by Dell could void your authority to operate this equipment.

This device complies with Part 15 of the FCC Rules. Operation is subject to the following two conditions:

- This device may not cause harmful interference.
- This device must accept any interference received, including interference that may cause undesired operation.

### **Class A**

This equipment has been tested and found to comply with the limits for a Class A digital device pursuant to Part 15 of the FCC Rules. These limits are designed to provide reasonable protection against harmful interference when the equipment is operated in a commercial environment. This equipment generates, uses, and can radiate radio frequency energy and, if not installed and used in accordance with the manufacturer's instruction manual, may cause harmful interference with radio communications. Operation of this equipment in a residential area is likely to cause harmful interference, in which case you will be required to correct the interference at your own expense.

## Class B

This equipment has been tested and found to comply with the limits for a Class B digital device pursuant to Part 15 of the FCC Rules. These limits are designed to provide reasonable protection against harmful interference in a residential installation. This equipment generates, uses, and can radiate radio frequency energy and, if not installed and used in accordance with the manufacturer's instruction manual, may cause interference with radio communications. However, there is no guarantee that interference will not occur in a particular installation. If this equipment does cause harmful interference to radio or television reception, which can be determined by turning the equipment off and on, you are encouraged to try to correct the interference by one or more of the following measures:

- Reorient or relocate the receiving antenna.
- Increase the separation between the equipment and the receiver.
- Connect the equipment into an outlet on a circuit different from that to which the receiver is connected.
- Consult the dealer or an experienced radio/television technician for help.

The following information is provided on the device or devices covered in this document in compliance with FCC regulations:

- Model number: PP01L
- Company name:  
Dell Computer Corporation  
One Dell Way  
Round Rock, Texas 78682 USA

## Modem Regulatory Information

This equipment complies with Part 68 of the FCC rules. On the bottom of your computer is a label that contains, among other information, the FCC registration number and ringer equivalence number (REN) for your equipment. If requested, you must provide this information to the telephone company.



The REN is used to determine the quantity of devices that may be connected to the telephone line. Excessive RENs on the telephone line may result in the devices not ringing in response to an incoming call. In most areas, the sum of all the RENs on your telephone line should be less than five to ensure proper service from the telephone company. To be certain of the number of devices that you may connect to a line, as determined by the total RENs, contact your local telephone company.

The registration jack Universal Service Order Code (USOC) used by this equipment is RJ-11C. An FCC compliant telephone cord and modular plug is provided with this equipment. This equipment is designed to be connected to the telephone network or premises wiring using a compatible modular jack that is Part 68 compliant.

This equipment cannot be used on public coin-phone service provided by the telephone company. Connection to party line service is subject to state tariffs.

There are no user serviceable parts on the modem contained in your computer.

If your telephone equipment causes harm to the telephone network, the telephone company will notify you in advance that service may be temporarily discontinued. If advance notice is not practical, the telephone company will notify you as soon as possible. Also, you will be advised of your right to file a complaint with the FCC if you believe it is necessary.

The telephone company may make changes in its facilities, equipment, operations, or procedures that could affect the operation of this equipment. If this happens, the telephone company will provide advance notice in order for you to make necessary modifications to maintain uninterrupted service.

If you experience trouble with this telephone equipment, see “Contacting Dell” on page 103 to find the appropriate contact information for obtaining customer assistance. If the equipment is causing harm to the telephone network, the telephone company may request that you disconnect the equipment until the problem is resolved.

### **Fax Branding**

The Telephone Consumer Protection Act of 1991 makes it unlawful for any person to use a computer or other electronic device, including fax machines, to send any message unless such message clearly contains in a margin at the top or bottom of each transmitted page or on the first page of the transmission, the date and time it is sent, identification of the business, other entity, or individual sending the message, and the telephone number of the sending machine or such business, other entity, or individual. The telephone number provided may not be a 900 number or any other number for which charges exceed local or long-distance transmission charges.

### **Battery Disposal**



Your computer uses a lithium-ion battery and a nickel-metal hydride (NiMH) coin-cell battery. For instructions about replacing the lithium-ion battery in your computer, see the *Tell Me How* help file. To access the help file, see page 34.

The coin-cell battery is a long-life battery, and it is very possible that you will never need to replace it. However, should you need to replace it, the procedure must be performed by an authorized service technician.

Do not dispose of the battery along with household waste. Contact your local waste disposal agency for the address of the nearest battery deposit site.

## NOM Information (Mexico Only)

The following information is provided on the device(s) described in this document in compliance with the requirements of the official Mexican standards (NOM):

Exporter:	Dell Computer Corporation One Dell Way Round Rock, TX 78682
Importer:	Dell Computer de México, S.A. de C.V. Paseo de la Reforma 2620 - 11° Piso Col. Lomas Altas 11950 México, D.F.
Ship to:	Dell Computer de México, S.A. de C.V. al Cuidado de Kuehne & Nagel de México S. de R.I. Avenida Soles No. 55 Col. Peñon de los Baños 15520 México, D.F.
Supply voltage:	100–240 VAC
Frequency:	50–60 Hz
Current consumption:	1.5 A
System input voltage:	20 VDC
System input current:	3.5 A

## Información para NOM (únicamente para México)

La información siguiente se proporciona en el dispositivo o en los dispositivos descritos en este documento, en cumplimiento con los requisitos de la Norma Oficial Mexicana (NOM):

Exportador:	Dell Computer Corporation One Dell Way Round Rock, TX 78682
Importador:	Dell Computer de México, S.A. de C.V. Paseo de la Reforma 2620 - 11° Piso Col. Lomas Altas 11950 México, D.F.
Embarcar a:	Dell Computer de México, S.A. de C.V. al Cuidado de Kuehne & Nagel de México S. de R.I. Avenida Soles No. 55 Col. Peñon de los Baños 15520 México, D.F.
Tensión alimentación:	100–240 VAC
Frecuencia:	50–60 Hz
Consumo de corriente:	1.5 A
Voltaje de entrada del sistema:	20 VDC
Corriente de entrada del sistema:	3.5 A

## Limited Warranties and Return Policy

Dell-branded hardware products purchased in the U.S. or Canada come with either a one-year limited warranty, a two-year limited warranty, or a three-year limited warranty. To determine which warranty you purchased, see the Dell invoice that accompanied your computer. The following sections describe these limited warranties, the one-year end-user guarantee for Latin America and the Caribbean, and the total satisfaction return policy.

## **One-Year Limited Warranty (U.S. Only)**

Dell Computer Corporation ("Dell") manufactures its hardware products from parts and components that are new or equivalent to new in accordance with industry-standard practices. Dell warrants that the hardware products it manufactures will be free from defects in materials and workmanship. The limited warranty term is one year beginning on the date of invoice, as further described in the following text.

Damage due to shipping the products to you is covered under this limited warranty. Otherwise, this limited warranty does not cover damage due to external causes, including accident, abuse, misuse, problems with electrical power, servicing not authorized by Dell, usage not in accordance with product instructions, failure to perform required preventive maintenance, and problems caused by use of parts and components not supplied by Dell.

This limited warranty does not cover any items that are in one or more of the following categories: software; external devices (except as specifically noted); accessories or parts added to a Dell system after the system is shipped from Dell; accessories or parts added to a Dell system through Dell's system integration department; accessories or parts that are not installed in the Dell factory; or DellWare™ products. Monitors, keyboards, and mice that are Dell-branded or that are included on Dell's standard price list are covered under this limited warranty; all other monitors, keyboards, and mice (including those sold through the DellWare program) are not covered.

Dell will repair or replace products covered under this limited warranty that are returned to Dell's facility. To request warranty service, you must contact Dell's Customer Technical Support within the limited warranty period. See "Contacting Dell" on page 103 to find the appropriate contact information for obtaining customer assistance. If warranty service is required, Dell will issue a Return Material Authorization Number. You must ship the products back to Dell in their original or equivalent packaging, prepay shipping charges, and insure the shipment or accept the risk of loss or damage during shipment. Dell will ship the repaired or replacement products to you (freight prepaid) if you use an address in the continental U.S., where applicable. Shipments to other locations will be made freight collect.

**NOTE:** Before you ship the product(s) to Dell, back up the data on the hard drive(s) and any other storage device(s) in the product(s). Remove any removable media, such as floppy disks, CDs, or PC Cards. Dell does not accept liability for lost data or software.

Dell owns all parts removed from repaired products. Dell uses new and reconditioned parts made by various manufacturers in performing warranty repairs and building replacement products. If Dell repairs or replaces a product, its warranty term is not extended.

THIS LIMITED WARRANTY GIVES YOU SPECIFIC LEGAL RIGHTS, AND YOU MAY ALSO HAVE OTHER RIGHTS, WHICH VARY FROM STATE TO STATE (OR JURISDICTION TO JURISDICTION). DELL'S RESPONSIBILITY FOR MALFUNCTIONS AND DEFECTS IN HARDWARE IS LIMITED TO REPAIR AND REPLACEMENT AS SET FORTH IN THIS LIMITED WARRANTY STATEMENT. ALL EXPRESS AND IMPLIED WARRANTIES FOR THE PRODUCT, INCLUDING BUT NOT LIMITED TO ANY IMPLIED WARRANTIES OF AND CONDITIONS OF MERCHANTABILITY AND FITNESS FOR A PARTICULAR PURPOSE, ARE LIMITED IN DURATION TO THE WARRANTY PERIOD SET FORTH ABOVE AND NO WARRANTIES, WHETHER EXPRESS OR IMPLIED, WILL APPLY AFTER SUCH PERIOD.

SOME STATES (OR JURISDICTIONS) DO NOT ALLOW LIMITATIONS ON HOW LONG AN IMPLIED WARRANTY LASTS, SO THE PRECEDING LIMITATION MAY NOT APPLY TO YOU.

DELL DOES NOT ACCEPT LIABILITY BEYOND THE REMEDIES SET FORTH IN THIS LIMITED WARRANTY STATEMENT OR LIABILITY FOR INCIDENTAL OR CONSEQUENTIAL DAMAGES, INCLUDING WITHOUT LIMITATION ANY LIABILITY FOR PRODUCTS NOT BEING AVAILABLE FOR USE OR FOR LOST DATA OR SOFTWARE.

SOME STATES (OR JURISDICTIONS) DO NOT ALLOW THE EXCLUSION OR LIMITATION OF INCIDENTAL OR CONSEQUENTIAL DAMAGES, SO THE PRECEDING EXCLUSION OR LIMITATION MAY NOT APPLY TO YOU.

These provisions apply to Dell's one-year limited warranty only. For provisions of any service contract covering your system, refer to your invoice or the separate service contract that you will receive.

If Dell elects to exchange a product or portion of a product, the exchange will be made in accordance with Dell's Exchange Policy in effect on the date of the exchange. In any instance in which Dell issues a Return Material Authorization Number, Dell must receive the product(s) for repair prior to the expiration of the warranty period in order for the repair(s) to be covered by the limited warranty.

### **Two-Year Limited Warranty (U.S. Only)**

Dell Computer Corporation ("Dell") manufactures its hardware products from parts and components that are new or equivalent to new in accordance with industry-standard practices. Dell warrants that the hardware products it manufactures will be free from defects in materials and workmanship. The limited warranty term is two years beginning on the date of invoice, as further described in the following section.

Damage due to shipping the products to you is covered under this warranty. Otherwise, this limited warranty does not cover damage due to external causes, including accident, abuse, misuse, problems with electrical power, servicing not authorized by Dell, usage not in accordance with product instructions, failure to perform required preventive maintenance, and problems caused by use of parts and components not supplied by Dell.

This limited warranty does not cover any items that are in one or more of the following categories: software; external devices (except as specifically noted); accessories or parts added to a Dell system after the system is shipped from Dell; accessories or parts added to a Dell system through Dell's system integration department; accessories or parts that are not installed in the Dell factory; or DellWare products. Monitors, keyboards, and mice that are Dell-branded or that are included on Dell's standard price list are covered under this warranty; all other monitors, keyboards, and mice (including those sold through the DellWare program) are not covered. Batteries for portable computers are covered only during the initial one-year period of this limited warranty.

### Limited Warranty Coverage During Year One

During the one-year period beginning on the invoice date, Dell will repair or replace products covered under this limited warranty that are returned to Dell's facility. To request warranty service, you must contact Dell's Customer Technical Support within the warranty period. See "Contacting Dell" on page 103 to find the appropriate contact information for obtaining customer assistance. If warranty service is required, Dell will issue a Return Material Authorization Number. You must ship the products back to Dell in their original or equivalent packaging, prepay shipping charges, and insure the shipment or accept the risk of loss or damage during shipment. Dell will ship the repaired or replacement products to you freight prepaid if you use an address in the continental U.S., where applicable. Shipments to other locations will be made freight collect.

**NOTE:** Before you ship the product(s) to Dell, back up the data on the hard drive(s) and any other storage device(s) in the product(s). Remove any removable media, such as floppy disks, CDs, or PC Cards. Dell does not accept liability for lost data or software.

Dell owns all parts removed from repaired products. Dell uses new and reconditioned parts made by various manufacturers in performing warranty repairs and building replacement products. If Dell repairs or replaces a product, its warranty term is not extended.

### Limited Warranty Coverage During Year Two

During the second year of this limited warranty, Dell will provide, on an exchange basis and subject to Dell's Exchange Policy in effect on the date of the exchange, replacement parts for the Dell hardware product(s) covered under this limited warranty when a part requires replacement. You must report each instance of hardware failure to Dell's Customer Technical Support in advance to obtain Dell's concurrence that a part should be replaced and to have Dell ship the replacement part. Dell will ship parts (freight prepaid) if you use an address in the continental U.S., where applicable. Shipments to other locations, where applicable, will be made freight collect. Dell will include a prepaid shipping container with each replacement part for your use in returning the replaced part to Dell. Replacement parts are new or reconditioned. Dell may provide replacement parts made by various manufacturers when supplying parts to you. The warranty term for a replacement part is the remainder of the limited warranty term.



You will pay Dell for replacement parts if the replaced part is not returned to Dell. The process for returning replaced parts, and your obligation to pay for replacement parts if you do not return the replaced parts to Dell, will be in accordance with Dell's Exchange Policy in effect on the date of the exchange.

You accept full responsibility for your software and data. Dell is not required to advise or remind you of appropriate backup and other procedures.

### **General Provisions**

THIS LIMITED WARRANTY GIVES YOU SPECIFIC LEGAL RIGHTS, AND YOU MAY ALSO HAVE OTHER RIGHTS, WHICH VARY FROM STATE TO STATE (OR JURISDICTION TO JURISDICTION). DELL'S RESPONSIBILITY FOR MALFUNCTIONS AND DEFECTS IN HARDWARE IS LIMITED TO REPAIR AND REPLACEMENT AS SET FORTH IN THIS LIMITED WARRANTY STATEMENT. ALL EXPRESS AND IMPLIED WARRANTIES FOR THE PRODUCT, INCLUDING BUT NOT LIMITED TO ANY IMPLIED WARRANTIES OF AND CONDITIONS OF MERCHANTABILITY AND FITNESS FOR A PARTICULAR PURPOSE, ARE LIMITED IN DURATION TO THE WARRANTY PERIOD SET FORTH ABOVE AND NO WARRANTIES, WHETHER EXPRESS OR IMPLIED, WILL APPLY AFTER SUCH PERIOD. SOME STATES (OR JURISDICTIONS) DO NOT ALLOW LIMITATIONS ON HOW LONG AN IMPLIED WARRANTY LASTS, SO THE PRECEDING LIMITATION MAY NOT APPLY TO YOU.

DELL DOES NOT ACCEPT LIABILITY BEYOND THE REMEDIES SET FORTH IN THIS LIMITED WARRANTY STATEMENT OR LIABILITY FOR INCIDENTAL OR CONSEQUENTIAL DAMAGES, INCLUDING WITHOUT LIMITATION ANY LIABILITY FOR PRODUCTS NOT BEING AVAILABLE FOR USE OR FOR LOST DATA OR SOFTWARE. SOME STATES (OR JURISDICTIONS) DO NOT ALLOW THE EXCLUSION OR LIMITATION OF INCIDENTAL OR CONSEQUENTIAL DAMAGES, SO THE PRECEDING EXCLUSION OR LIMITATION MAY NOT APPLY TO YOU.

These provisions apply to Dell's two-year limited warranty only. For provisions of any service contract covering your system, refer to your invoice or the separate service contract that you will receive.

If Dell elects to exchange a system or component, the exchange will be made in accordance with Dell's Exchange Policy in effect on the date of the exchange. In any instance in which Dell issues a Return Material Authorization Number, Dell must receive the product(s) for repair prior to the expiration of the warranty period in order for the repair(s) to be covered by the limited warranty.

### **Three-Year Limited Warranty (U.S. Only)**

Dell Computer Corporation ("Dell") manufactures its hardware products from parts and components that are new or equivalent to new in accordance with industry-standard practices. Dell warrants that the hardware products it manufactures will be free from defects in materials and workmanship. The limited warranty term is three years beginning on the date of invoice, as described in the following text.

Damage due to shipping the products to you is covered under this limited warranty. Otherwise, this limited warranty does not cover damage due to external causes, including accident, abuse, misuse, problems with electrical power, servicing not authorized by Dell, usage not in accordance with product instructions, failure to perform required preventive maintenance, and problems caused by use of parts and components not supplied by Dell.

This limited warranty does not cover any items that are in one or more of the following categories: software; external devices (except as specifically noted); accessories or parts added to a Dell system after the system is shipped from Dell; accessories or parts added to a Dell system through Dell's system integration department; accessories or parts that are not installed in the Dell factory; or DellWare products. Monitors, keyboards, and mice that are Dell-branded or that are included on Dell's standard price list are covered under this limited warranty; all other monitors, keyboards, and mice (including those sold through the DellWare program) are not covered. Batteries for portable computers are covered only during the initial one-year period of this limited warranty.

## Coverage During Year One

During the one-year period beginning on the invoice date, Dell will repair or replace products covered under this limited warranty that are returned to Dell's facility. To request warranty service, you must contact Dell's Customer Technical Support within the warranty period. See "Contacting Dell" on page 103 to find the appropriate contact information for obtaining customer assistance. If warranty service is required, Dell will issue a Return Material Authorization Number. You must ship the products back to Dell in their original or equivalent packaging, prepay shipping charges, and insure the shipment or accept the risk of loss or damage during shipment. Dell will ship the repaired or replacement products to you freight prepaid if you use an address in the continental U.S., where applicable. Shipments to other locations will be made freight collect.

**NOTE:** Before you ship the product(s) to Dell, back up the data on the hard drive(s) and any other storage device(s) in the product(s). Remove any removable media, such as floppy disks, CDs, or PC Cards. Dell does not accept liability for lost data or software.

Dell owns all parts removed from repaired products. Dell uses new and reconditioned parts made by various manufacturers in performing warranty repairs and building replacement products. If Dell repairs or replaces a product, its warranty term is not extended.

## Coverage During Years Two and Three

During the second and third years of this limited warranty, Dell will provide, on an exchange basis and subject to Dell's Exchange Policy in effect on the date of the exchange, replacement parts for the Dell hardware product(s) covered under this limited warranty when a part requires replacement. You must report each instance of hardware failure to Dell's Customer Technical Support in advance to obtain Dell's concurrence that a part should be replaced and to have Dell ship the replacement part. Dell will ship parts (freight prepaid) if you use an address in the continental U.S., where applicable. Shipments to other locations will be made freight collect. Dell will include a prepaid shipping container with each replacement part for your use in returning the replaced part to Dell. Replacement parts are new or reconditioned. Dell may provide replacement parts made by various manufacturers when supplying parts to you. The warranty term for a replacement part is the remainder of the limited warranty term.

You will pay Dell for replacement parts if the replaced part is not returned to Dell. The process for returning replaced parts, and your obligation to pay for replacement parts if you do not return the replaced parts to Dell, will be in accordance with Dell's Exchange Policy in effect on the date of the exchange.

You accept full responsibility for your software and data. Dell is not required to advise or remind you of appropriate backup and other procedures.

### **General Provisions**

THIS LIMITED WARRANTY GIVES YOU SPECIFIC LEGAL RIGHTS, AND YOU MAY ALSO HAVE OTHER RIGHTS, WHICH VARY FROM STATE TO STATE (OR JURISDICTION TO JURISDICTION). DELL'S RESPONSIBILITY FOR MALFUNCTIONS AND DEFECTS IN HARDWARE IS LIMITED TO REPAIR AND REPLACEMENT AS SET FORTH IN THIS LIMITED WARRANTY STATEMENT. ALL EXPRESS AND IMPLIED WARRANTIES FOR THE PRODUCT, INCLUDING BUT NOT LIMITED TO ANY IMPLIED WARRANTIES OF AND CONDITIONS OF MERCHANTABILITY AND FITNESS FOR A PARTICULAR PURPOSE, ARE LIMITED IN DURATION TO THE WARRANTY PERIOD SET FORTH ABOVE AND NO WARRANTIES, WHETHER EXPRESS OR IMPLIED, WILL APPLY AFTER SUCH PERIOD.

SOME STATES (OR JURISDICTIONS) DO NOT ALLOW LIMITATIONS ON HOW LONG AN IMPLIED WARRANTY LASTS, SO THE PRECEDING LIMITATION MAY NOT APPLY TO YOU.

DELL DOES NOT ACCEPT LIABILITY BEYOND THE REMEDIES SET FORTH IN THIS LIMITED WARRANTY STATEMENT OR LIABILITY FOR INCIDENTAL OR CONSEQUENTIAL DAMAGES, INCLUDING WITHOUT LIMITATION ANY LIABILITY FOR PRODUCTS NOT BEING AVAILABLE FOR USE OR FOR LOST DATA OR SOFTWARE.

SOME STATES (OR JURISDICTIONS) DO NOT ALLOW THE EXCLUSION OR LIMITATION OF INCIDENTAL OR CONSEQUENTIAL DAMAGES, SO THE PRECEDING EXCLUSION OR LIMITATION MAY NOT APPLY TO YOU.

These provisions apply to Dell's three-year limited warranty only. For provisions of any service contract covering your system, refer to your invoice or the separate service contract that you will receive.

If Dell elects to exchange a system or component, the exchange will be made in accordance with Dell's Exchange Policy in effect on the date of the exchange. In any instance in which Dell issues a Return Material Authorization Number, Dell must receive the product(s) for repair prior to the expiration of the warranty period in order for the repair(s) to be covered by the limited warranty.

### **One-Year Limited Warranty (Canada Only)**

Dell Computer Corporation ("Dell") manufactures its hardware products from parts and components that are new or equivalent to new in accordance with industry-standard practices. Dell warrants that the hardware products it manufactures will be free from defects in materials and workmanship. The limited warranty term is one year beginning on the date of invoice, as further described in the following text.

Damage due to shipping the products to you is covered under this limited warranty. Otherwise, this limited warranty does not cover damage due to external causes, including accident, abuse, misuse, problems with electrical power, servicing not authorized by Dell, usage not in accordance with product instructions, failure to perform required preventive maintenance, and problems caused by use of parts and components not supplied by Dell.

This limited warranty does not cover any items that are in one or more of the following categories: software; external devices (except as specifically noted); accessories or parts added to a Dell system after the system is shipped from Dell; accessories or parts added to a Dell system through Dell's system integration department; accessories or parts that are not installed in the Dell factory; or DellWare products. Monitors, keyboards, and mice that are Dell-branded or that are included on Dell's standard price list are covered under this limited warranty; all other monitors, keyboards, and mice (including those sold through the DellWare program) are not covered.

Dell will repair or replace products covered under this limited warranty that are returned to Dell's facility. To request warranty service, you must contact Dell's Customer Technical Support within the warranty period. See "Contacting Dell" on page 103 to find the appropriate contact information for obtaining customer assistance. If warranty service is required, Dell will issue a Return Material Authorization Number. You must ship the products back to Dell in their original or equivalent packaging, prepay shipping charges, and insure the shipment or accept the risk of loss or damage during shipment. Dell will ship the repaired or replacement products to you (freight prepaid) if you use an address in Canada, where applicable. Shipments to other locations will be made freight collect.

**NOTE:** Before you ship the product(s) to Dell, back up the data on the hard drive(s) and any other storage device(s) in the product(s). Remove any removable media, such as floppy disks, CDs, or PC Cards. Dell does not accept liability for lost data or software.

Dell owns all parts removed from repaired products. Dell uses new and reconditioned parts made by various manufacturers in performing warranty repairs and building replacement products. If Dell repairs or replaces a product, its warranty term is not extended.

DELL MAKES NO EXPRESS WARRANTIES OR CONDITIONS BEYOND THOSE STATED IN THIS LIMITED WARRANTY STATEMENT. DELL DISCLAIMS ALL OTHER WARRANTIES AND CONDITIONS, EXPRESS OR IMPLIED, INCLUDING WITHOUT LIMITATION IMPLIED WARRANTIES AND CONDITIONS OF MERCHANTABILITY AND FITNESS FOR A PARTICULAR PURPOSE. SOME STATES (OR JURISDICTIONS) DO NOT ALLOW LIMITATIONS ON IMPLIED WARRANTIES OR CONDITIONS, SO THIS LIMITATION MAY NOT APPLY TO YOU.

DELL'S RESPONSIBILITY FOR MALFUNCTIONS AND DEFECTS IN HARDWARE IS LIMITED TO REPAIR AND REPLACEMENT AS SET FORTH IN THIS LIMITED WARRANTY STATEMENT. THESE WARRANTIES GIVE YOU SPECIFIC LEGAL RIGHTS, AND YOU MAY ALSO HAVE OTHER RIGHTS, WHICH VARY FROM STATE TO STATE (OR JURISDICTION TO JURISDICTION).

DELL DOES NOT ACCEPT LIABILITY BEYOND THE REMEDIES SET FORTH IN THIS LIMITED WARRANTY STATEMENT OR LIABILITY FOR INCIDENTAL OR CONSEQUENTIAL DAMAGES, INCLUDING WITHOUT LIMITATION ANY LIABILITY FOR PRODUCTS NOT BEING AVAILABLE FOR USE OR FOR LOST DATA OR SOFTWARE.

SOME STATES (OR JURISDICTIONS) DO NOT ALLOW THE EXCLUSION OR LIMITATION OF INCIDENTAL OR CONSEQUENTIAL DAMAGES, SO THE PRECEDING EXCLUSION OR LIMITATION MAY NOT APPLY TO YOU.

These provisions apply to Dell's one-year limited warranty only. For provisions of any service contract covering your system, refer to your invoice or the separate service contract that you will receive.

If Dell elects to exchange a product or portion of a product, the exchange will be made in accordance with Dell's Exchange Policy in effect on the date of the exchange. In any instance in which Dell issues a Return Material Authorization Number, Dell must receive the product(s) for repair prior to the expiration of the warranty period in order for the repair(s) to be covered by the limited warranty.

### **Two-Year Limited Warranty (Canada Only)**

Dell Computer Corporation ("Dell") manufactures its hardware products from parts and components that are new or equivalent to new in accordance with industry-standard practices. Dell warrants that the hardware products it manufactures will be free from defects in materials and workmanship. The warranty term is two years beginning on the date of invoice, as described in the following text.

Damage due to shipping the products to you is covered under this limited warranty. Otherwise, this limited warranty does not cover damage due to external causes, including accident, abuse, misuse, problems with electrical power, servicing not authorized by Dell, usage not in accordance with product instructions, failure to perform required preventive maintenance, and problems caused by use of parts and components not supplied by Dell.

This limited warranty does not cover any items that are in one or more of the following categories: software; external devices (except as specifically noted); accessories or parts added to a Dell system after the system is shipped from Dell; accessories or parts added to a Dell system through Dell's system integration department; accessories or parts that are not installed in the Dell factory; or DellWare products. Monitors, keyboards, and mice that are Dell-branded or that are included on Dell's standard price list are covered under this limited warranty; all other monitors, keyboards, and mice (including those sold through the DellWare program) are not covered. Batteries for portable computers are covered only during the initial one-year period of this limited warranty.

### Coverage During Year One

During the one-year period beginning on the invoice date, Dell will repair or replace products covered under this limited warranty that are returned to Dell's facility. To request warranty service, you must contact Dell's Customer Technical Support within the warranty period. See "Contacting Dell" on page 103 to find the appropriate contact information for obtaining customer assistance. If warranty service is required, Dell will issue a Return Material Authorization Number. You must ship the products back to Dell in their original or equivalent packaging, prepay shipping charges, and insure the shipment or accept the risk of loss or damage during shipment. Dell will ship the repaired or replacement products to you freight prepaid if you use an address in Canada, where applicable. Shipments to other locations will be made freight collect.

**NOTE:** Before you ship the product(s) to Dell, back up the data on the hard drive(s) and any other storage device(s) in the product(s). Remove any removable media, such as floppy disks, CDs, or PC Cards. Dell does not accept liability for lost data or software.

Dell owns all parts removed from repaired products. Dell uses new and reconditioned parts made by various manufacturers in performing warranty repairs and building replacement products. If Dell repairs or replaces a product, its warranty term is not extended.



## **Coverage During Year Two**

During the second year of this limited warranty, Dell will provide, on an exchange basis and subject to Dell's Exchange Policy in effect on the date of the exchange, replacement parts for the Dell hardware product(s) covered under this limited warranty when a part requires replacement. You must report each instance of hardware failure to Dell's Customer Technical Support in advance to obtain Dell's concurrence that a part should be replaced and to have Dell ship the replacement part. Dell will ship parts (freight prepaid) if you use an address in Canada, where applicable. Shipments to other locations will be made freight collect. Dell will include a prepaid shipping container with each replacement part for your use in returning the replaced part to Dell. Replacement parts are new or reconditioned. Dell may provide replacement parts made by various manufacturers when supplying parts to you. The warranty term for a replacement part is the remainder of the limited warranty term.

You will pay Dell for replacement parts if the replaced part is not returned to Dell. The process for returning replaced parts, and your obligation to pay for replacement parts if you do not return the replaced parts to Dell, will be in accordance with Dell's Exchange Policy in effect on the date of the exchange.

You accept full responsibility for your software and data. Dell is not required to advise or remind you of appropriate backup and other procedures.

## **General Provisions**

DELL MAKES NO EXPRESS WARRANTIES OR CONDITIONS BEYOND THOSE STATED IN THIS LIMITED WARRANTY STATEMENT. DELL DISCLAIMS ALL OTHER WARRANTIES AND CONDITIONS, EXPRESS OR IMPLIED, INCLUDING WITHOUT LIMITATION IMPLIED WARRANTIES AND CONDITIONS OF MERCHANTABILITY AND FITNESS FOR A PARTICULAR PURPOSE. SOME STATES (OR JURISDICTIONS) DO NOT ALLOW LIMITATIONS ON IMPLIED WARRANTIES OR CONDITIONS, SO THIS LIMITATION MAY NOT APPLY TO YOU.

DELL'S RESPONSIBILITY FOR MALFUNCTIONS AND DEFECTS IN HARDWARE IS LIMITED TO REPAIR AND REPLACEMENT AS SET FORTH IN THIS LIMITED WARRANTY STATEMENT. THESE WARRANTIES GIVE YOU SPECIFIC LEGAL RIGHTS, AND YOU MAY ALSO HAVE OTHER RIGHTS, WHICH VARY FROM STATE TO STATE (OR JURISDICTION TO JURISDICTION).

DELL DOES NOT ACCEPT LIABILITY BEYOND THE REMEDIES SET FORTH IN THIS LIMITED WARRANTY STATEMENT OR LIABILITY FOR INCIDENTAL OR CONSEQUENTIAL DAMAGES, INCLUDING WITHOUT LIMITATION ANY LIABILITY FOR PRODUCTS NOT BEING AVAILABLE FOR USE OR FOR LOST DATA OR SOFTWARE.

SOME STATES (OR JURISDICTIONS) DO NOT ALLOW THE EXCLUSION OR LIMITATION OF INCIDENTAL OR CONSEQUENTIAL DAMAGES, SO THE PRECEDING EXCLUSION OR LIMITATION MAY NOT APPLY TO YOU.

These provisions apply to Dell's two-year limited warranty only. For provisions of any service contract covering your system, refer to your invoice or the separate service contract that you will receive.

If Dell elects to exchange a system or component, the exchange will be made in accordance with Dell's Exchange Policy in effect on the date of the exchange. In any instance in which Dell issues a Return Material Authorization Number, Dell must receive the product(s) for repair prior to the expiration of the warranty period in order for the repair(s) to be covered by the limited warranty.

### **Three-Year Limited Warranty (Canada Only)**

Dell Computer Corporation ("Dell") manufactures its hardware products from parts and components that are new or equivalent to new in accordance with industry-standard practices. Dell warrants that the hardware products it manufactures will be free from defects in materials and workmanship. The warranty term is three years beginning on the date of invoice, as described in the following text.

Damage due to shipping the products to you is covered under this limited warranty. Otherwise, this limited warranty does not cover damage due to external causes, including accident, abuse, misuse, problems with electrical power, servicing not authorized by Dell, usage not in accordance with product instructions, failure to perform required preventive maintenance, and problems caused by use of parts and components not supplied by Dell.

This limited warranty does not cover any items that are in one or more of the following categories: software; external devices (except as specifically noted); accessories or parts added to a Dell system after the system is shipped from Dell; accessories or parts added to a Dell system through Dell's system integration department; accessories or parts that are not installed in the Dell factory; or DellWare products. Monitors, keyboards, and mice that are Dell-branded or that are included on Dell's standard price list are covered under this limited warranty; all other monitors, keyboards, and mice (including those sold through the DellWare program) are not covered. Batteries for portable computers are covered only during the initial one-year period of this limited warranty.

### **Coverage During Year One**

During the one-year period beginning on the invoice date, Dell will repair or replace products covered under this limited warranty that are returned to Dell's facility. To request warranty service, you must contact Dell's Customer Technical Support within the warranty period. See "Contacting Dell" on page 103 to find the appropriate contact information for obtaining customer assistance. If warranty service is required, Dell will issue a Return Material Authorization Number. You must ship the products back to Dell in their original or equivalent packaging, prepay shipping charges, and insure the shipment or accept the risk of loss or damage during shipment. Dell will ship the repaired or replacement products to you freight prepaid if you use an address in Canada, where applicable. Shipments to other locations will be made freight collect.

**NOTE:** Before you ship the product(s) to Dell, back up the data on the hard drive(s) and any other storage device(s) in the product(s). Remove any removable media, such as floppy disks, CDs, or PC Cards. Dell does not accept liability for lost data or software.

Dell owns all parts removed from repaired products. Dell uses new and reconditioned parts made by various manufacturers in performing warranty repairs and building replacement products. If Dell repairs or replaces a product, its warranty term is not extended.

### **Coverage During Years Two and Three**

During the second and third years of this limited warranty, Dell will provide, on an exchange basis and subject to Dell's Exchange Policy in effect on the date of the exchange, replacement parts for the Dell hardware product(s) covered under this limited warranty when a part requires replacement. You must report each instance of hardware failure to Dell's Customer Technical Support in advance to obtain Dell's concurrence that a part should be replaced and to have Dell ship the replacement part. Dell will ship parts (freight prepaid) if you use an address in Canada, where applicable. Shipments to other locations will be made freight collect. Dell will include a prepaid shipping container with each replacement part for your use in returning the replaced part to Dell. Replacement parts are new or reconditioned. Dell may provide replacement parts made by various manufacturers when supplying parts to you. The warranty term for a replacement part is the remainder of the limited warranty term.

You will pay Dell for replacement parts if the replaced part is not returned to Dell. The process for returning replaced parts, and your obligation to pay for replacement parts if you do not return the replaced parts to Dell, will be in accordance with Dell's Exchange Policy in effect on the date of the exchange.

You accept full responsibility for your software and data. Dell is not required to advise or remind you of appropriate backup and other procedures.

## **General Provisions**

DELL MAKES NO EXPRESS WARRANTIES OR CONDITIONS BEYOND THOSE STATED IN THIS LIMITED WARRANTY STATEMENT. DELL DISCLAIMS ALL OTHER WARRANTIES AND CONDITIONS, EXPRESS OR IMPLIED, INCLUDING WITHOUT LIMITATION IMPLIED WARRANTIES AND CONDITIONS OF MERCHANTABILITY AND FITNESS FOR A PARTICULAR PURPOSE. SOME STATES (OR JURISDICTIONS) DO NOT ALLOW LIMITATIONS ON IMPLIED WARRANTIES OR CONDITIONS, SO THIS LIMITATION MAY NOT APPLY TO YOU.

DELL'S RESPONSIBILITY FOR MALFUNCTIONS AND DEFECTS IN HARDWARE IS LIMITED TO REPAIR AND REPLACEMENT AS SET FORTH IN THIS LIMITED WARRANTY STATEMENT. THESE WARRANTIES GIVE YOU SPECIFIC LEGAL RIGHTS, AND YOU MAY ALSO HAVE OTHER RIGHTS, WHICH VARY FROM STATE TO STATE (OR JURISDICTION TO JURISDICTION).

DELL DOES NOT ACCEPT LIABILITY BEYOND THE REMEDIES SET FORTH IN THIS LIMITED WARRANTY STATEMENT OR LIABILITY FOR INCIDENTAL OR CONSEQUENTIAL DAMAGES, INCLUDING WITHOUT LIMITATION ANY LIABILITY FOR PRODUCTS NOT BEING AVAILABLE FOR USE OR FOR LOST DATA OR SOFTWARE.

SOME STATES (OR JURISDICTIONS) DO NOT ALLOW THE EXCLUSION OR LIMITATION OF INCIDENTAL OR CONSEQUENTIAL DAMAGES, SO THE PRECEDING EXCLUSION OR LIMITATION MAY NOT APPLY TO YOU.

These provisions apply to Dell's three-year limited warranty only. For provisions of any service contract covering your system, refer to your invoice or the separate service contract that you will receive.

If Dell elects to exchange a system or component, the exchange will be made in accordance with Dell's Exchange Policy in effect on the date of the exchange. In any instance in which Dell issues a Return Material Authorization Number, Dell must receive the product(s) for repair prior to the expiration of the warranty period in order for the repair(s) to be covered by the limited warranty.

### **"Total Satisfaction" Return Policy (U.S. and Canada Only)**

If you are an end-user customer who bought new products directly from a Dell company, you may return them to Dell within 30 days of the date of invoice for a refund or credit of the product purchase price. If you are an end-user customer who bought reconditioned or refurbished products from a Dell company, you may return them to Dell within 14 days of the date of invoice for a refund or credit of the product purchase price. In either case, the refund or credit will not include any shipping and handling charges shown on your invoice. If you are an organization that bought the products under a written agreement with Dell, the agreement may contain different terms for the return of products than specified by this policy.

To return products, you must contact Dell Customer Service to receive a Credit Return Authorization Number. See “Contacting Dell” on page 103 to find the appropriate contact information for obtaining customer assistance. To expedite the processing of your refund or credit, Dell expects you to return the products to Dell in their original packaging within five days of the date that Dell issues the Credit Return Authorization Number. You must also prepay shipping charges and insure the shipment or accept the risk of loss or damage during shipment. You may return software for refund or credit only if the sealed package containing the diskette(s) or CD(s) is unopened. Returned products must be in as-new condition, and all of the manuals, diskette(s), CD(s), power cables, and other items included with a product must be returned with it. For customers who want to return, for refund or credit only, either applications software or an operating system that has been installed by Dell, the whole system must be returned, along with any media and documentation that may have been included in the original shipment.

This "Total Satisfaction" Return Policy does not apply to DellWare products, which may be returned under DellWare's then-current return policy. In addition, reconditioned parts purchased through Dell Spare Parts Sales in Canada are nonreturnable.

## **One-Year End-User Manufacturer Guarantee (Latin America and the Caribbean Only)**

### **Guarantee**

Dell Computer Corporation ("Dell") warrants to the end user in accordance with the following provisions that its branded hardware products, purchased by the end user from a Dell company or an authorized Dell distributor in Latin America or the Caribbean, will be free from defects in materials, workmanship, and design affecting normal use, for a period of one year from the original purchase date. Products for which proper claims are made will, at Dell's option, be repaired or replaced at Dell's expense. Dell owns all parts removed from repaired products. Dell uses new and reconditioned parts made by various manufacturers in performing repairs and building replacement products.

### **Exclusions**

This Guarantee does not apply to defects resulting from: improper or inadequate installation, use, or maintenance; actions or modifications by unauthorized third parties or the end user; accidental or willful damage; or normal wear and tear.

### **Making a Claim**

Claims must be made in Latin America or the Caribbean by contacting the Dell point of sale within the guarantee period. The end user must always supply proof of purchase, indicating name and address of the seller, date of purchase, model and serial number, name and address of the customer, and details of symptoms and configuration at the time of malfunction, including peripherals and software used. Otherwise, Dell may refuse the guarantee claim. Upon diagnosis of a warranted defect, Dell will make arrangements and pay for ground freight and insurance to and from Dell's repair/replacement center. The end user must ensure that the defective product is available for collection properly packed in original or equally protective packaging together with the details listed above and the return number provided to the end user by Dell.

### **Limitation and Statutory Rights**

Dell makes no other warranty, guarantee or like statement other than as explicitly stated above, and this Guarantee is given in place of all other guarantees whatsoever, to the fullest extent permitted by law. In the absence of applicable legislation, this Guarantee will be the end user's sole and exclusive remedy against Dell or any of its affiliates, and neither Dell nor any of its affiliates shall be liable for loss of profit or contracts, or any other indirect or consequential loss arising from negligence, breach of contract, or howsoever.

**This Guarantee does not impair or affect mandatory statutory rights of the end user against and/or any rights resulting from other contracts concluded by the end user with Dell and/or any other seller.**

#### **Dell World Trade LP**

One Dell Way, Round Rock, TX 78682, USA

**Dell Computadores do Brasil Ltda (CNPJ No. 72.381.189/0001-10)/**

**Dell Commercial do Brasil Ltda (CNPJ No. 03 405 822/0001-40)**

Avenida Industrial Belgraf, 400

92990-000 - Eldorado do Sul – RS - Brasil

#### **Dell Computer de Chile Ltda**

Coyancura 2283, Piso 3- Of.302,

Providencia, Santiago - Chile

#### **Dell Computer de Colombia Corporation**

Carrera 7 #115-33 Oficina 603

Bogota, Colombia

#### **Dell Computer de Mexico SA de CV**

Paseo de la Reforma 2620 - 11° Piso

Col. Lomas Altas

11950 México, D.F.



# Index

## A

- advanced port replicator
  - connecting to a network, 28
- APR
  - connecting to a network, 28
  - docking the computer, 76

## B

- BIOS, 101

## C

- CD-RW drive
  - fixing problems, 52
- characters
  - unexpected, 49
- computer
  - crashes, 54
  - specifications, 94
  - turning off, 24
- conflicts
  - resolving software and hardware incompatibilities, 62
- crashes, 54

## D

- damaged computer
  - testing, 57

- Dolby Headphone
  - setting up, 27

- drives
  - fixing problems, 49

- DVD drive
  - fixing problems, 52

## E

- electrostatic discharge. See ESD
- e-mail
  - fixing problems, 56
- ESD, 17

## F

- finding solutions, 32
- floppy drive
  - fixing problems, 49

## H

- hard drive
  - preventing damage, 88
  - preventing data loss, 87
  - replacing, 87
  - returning to Dell, 89
- help file
  - accessing, 34

- hibernate file
  - enable support, 73

## I

- infrared sensor
  - enabling, 26
- IRQ conflicts, 62

## K

- keyboard
  - fixing problems, 48, 49
  - unexpected characters, 49

## M

- memory
  - adding, 81
  - removing, 82
- Mini PCI card
  - adding, 85
- modem
  - adding, 90
  - fixing problems, 43
- module bay
  - swapping devices (active mode), 25
  - swapping devices (computer off), 25

## N

- network
  - fixing problems, 53
  - setting up the APR, 28

## P

- port replicator
  - connecting to a network, 28
  - docking the computer, 76
- power
  - fixing problems, 35
  - turning off, 24
- power protection
  - line conditioners, 29
  - surge protectors, 28
  - UPS, 29
- printer
  - connecting, 20
  - reinstalling driver, 22
  - setting up, 20
- programs
  - crashes, 54
  - fixing problems, 54
  - not responding, 54

## R

- RAM. *See* memory
- regulatory notices, 119
- reinstalling drivers and utilities, 58
- return policy, 142

## S

- safety instructions
  - ESD prevention, 17
- settings
  - system setup program, 101
- shutdown, 24
- software
  - fixing problems, 54
- specifications, 94
- System Restore, 65
- system setup program, 101

## T

- Tell Me How help file
  - accessing, 34
- troubleshooting
  - about, 32
  - blue screen, 55
  - cannot play a DVD movie, 52
  - cannot save to floppy disk, 49
  - CD-RW drive stops writing, 52
  - dropped or damaged computer, 57
  - e-mail problems, 56
  - external keyboard problems, 48
  - modem problems, 43
  - network problems, 53
  - parallel printer problems, 41
  - power problems, 35
  - program crash, 54
  - program stopped responding, 54
  - scanner problems, 46

- troubleshooting (*continued*)
  - unexpected characters, 49
  - USB printer problems, 42
  - wet computer, 56
- turning off the computer, 24

## U

- Using, 61

## W

- warranty, 124
- wet computer, 56
- Windows 2000
  - Display Settings, 39
  - display settings, 39
  - Help, 34
  - Printer, 42
  - printer, 42
  - reinstalling, 72
  - shutdown, 24
- Windows Me
  - Display Settings, 39
  - Help, 34
  - printer, 42
  - reinstalling, 70
  - shutdown, 24
- Windows XP
  - device driver rollback, 61
  - Help, 34
  - printer, 42
  - shutdown, 24